

EUROMASK®

SILICONE ADHESIVE - NASTRI CARTA - STAMPATI SPECIALI - BIADESIVI



TAPPI - HOOKS - NASTRI ADESIVI - CAPS - STAMPATI SPECIALI - CUT



CORDS - CAPPUCCI - SILICONE FOAMS - GANCI - DIE CUTS - PLUGS - FLT



POLYIMIDE TAPES - AUTOAGGLOMERANTE - SPECIAL ENGINEERED - EPDM



Powered by
FINISHING GROUP srl



ISO 9001
BUREAU VERITAS
Certification
Sistema Qualità Certificato
Certified Quality System

RELEASE
**EMK
K19 I**

**"WE SOLVE
EVERY MASKING
PROBLEM"**



Euromask® è leader nella produzione e distribuzione di sistemi professionali di mascheratura per tutti i trattamenti superficiali. Da ormai 20 anni, Euromask® distribuisce in tutto il mondo la sua ampia gamma di tappi, cappucci, ganci per la verniciatura, nastri e bollini, tubi e prodotti stampati speciali.

Velocità, flessibilità e professionalità sono le parole chiave del successo di Euromask®:

- Evasione dell'85% degli ordini in 24/48 ore
- 60 milioni di pezzi a magazzino
- Campionatura in tempi brevi: per gli adesivi in 3-4 giorni e produzione in 10 di giorni, per gli stampati in 1 settimana e produzione in 4 settimane.

Sistemi di mascheratura per le operazioni di verniciatura a polvere, liquido, anodizzazione e cromatura. Tappi conici e cappucci per la protezione di fori e filetti nelle operazioni di verniciatura, resistenti fino a 315°C. e riutilizzabili. Nastri e bollini adesivi per le operazioni di verniciatura a polveri e nei processi galvanici, metallizzazione e anodizzazione.

Condizioni di vendita: Spedizione a mezzo corriere espresso. Ordine minimo € 150,00

**Schede tecniche disponibili a richiesta
Catalogo valido da Gennaio 2019**

Finishing Group s.r.l. si riserva il diritto di apportare modifiche ai prodotti, prezzi e condizioni di fornitura senza alcun preavviso.



Euromask® is a leader in the production and distribution of professional masking systems for all surface treatments. Since 20 years Euromask® has been distributing its wide range of plugs, caps and painting hooks, tapes and discs, tubing and special moulded products worldwide.

Speed, flexibility and professionalism are the key words to Euromask®'s success:

- Execution of 85% of orders within 24/48 hours
- 60 million pieces in stock
- Fast sampling times: for adhesives 3-4 days with production in about ten days, for moulded items 1 week with production in 4 weeks.

Masking systems for powder and liquid painting operations, anodizing and chromium plating. Conical plugs and caps for the protection of holes and threads in painting operations. Resisting up to 315°C. and reusable. Tapes and adhesive disks for masking operations in powder painting and galvanic processes, metallization and anodizing.

Sales Terms: Shipment by express carrier. Minimum order € 150,00

**Technical data sheets availables on demand
Catalog available from January 2019**

Finishing Group s.r.l. reserve to make any necessary modification to products, prices and supply conditions without notice.

EUROMASK®

IN THE WORLD

SEDE - UFFICI - PRODUZIONE
PROGETTAZIONE - MAGAZZINO

MILANO
ITALIA

UFFICI - PRODUZIONE - MAGAZZINO

CHRZANOW
POLONIA

LERMA
MESSICO

UFFICI - MAGAZZINO

DOBRA VODA
SLOVACCHIA

SEVILLA
SPAGNA

IASI
ROMANIA

FINISHING GROUP - SEDI

RIVENDITORI ESTERI



MASKLOGIK POLAND

phone +48 326 240 020

Fax +48 326 240 020

biuro@masklogik.com

MASKLOGIK MÉXICO

phone +52 728 284 0120

Fax +52 728 284 0121

info@masklogik.com.mx

MASKLOGIK SLOVAKIA

phone +421 915 714 105

info@masklogik.com

MASKLOGIK SPAIN - Fle&Mask S.L.

Movíl +34 657 577 965

Móvil +34 603 216 058

ventas@masklogik.com

MASKLOGIK ROMANIA

phone +40 332 443 853

Fax +40 332 443 853

info@masklogik.com

EUROMASK®

RISOLVIAMO OGNI PROBLEMA DI MASCHERATURA



IT Ganci in acciaio e ferro per verniciatura.

EN Steel and iron hooks for painting.

HOOKS HOOKS

Altre forme e dimensioni realizzabili a richiesta
Other sizes and drawings on demand

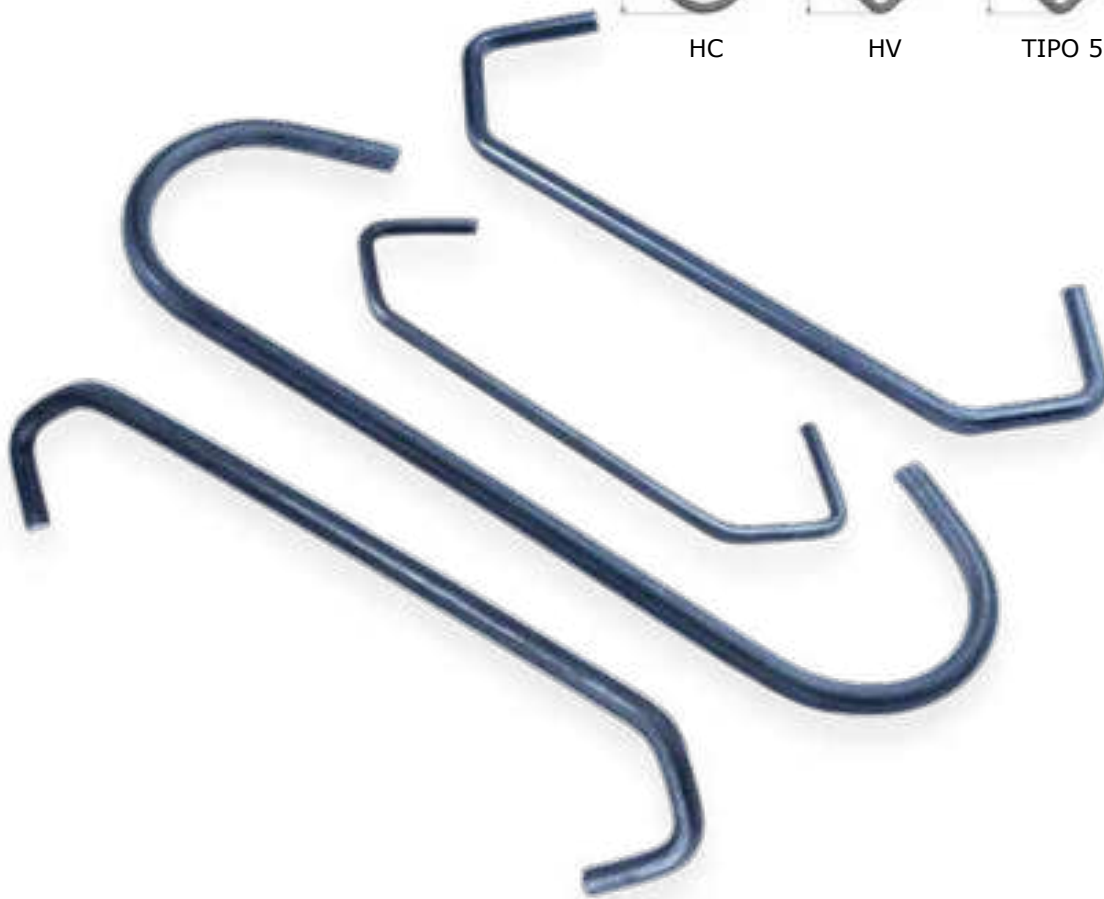
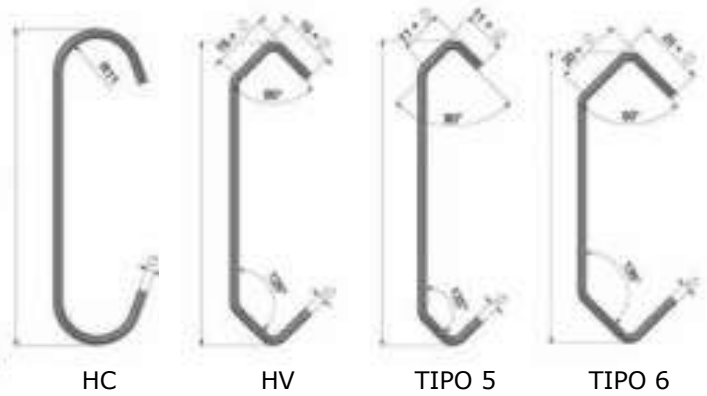

LUNGH LENGTH	Ø 1,5 mm 1000 pcs	Ø 2 mm 1000 pcs	Ø 3 mm 1000 pcs	Ø 4 mm 1000 pcs	Ø 5 mm 1000 pcs
60 mm	14,49	17,53	33,26	83,77	--
75 mm	15,01	18,41	37,69	83,51	--
100 mm	15,88	19,89	43,07	93,31	135,99
150 mm	20,15	22,84	53,48	113,05	170,19
200 mm	23,70	25,79	59,21	129,23	204,39
250 mm	26,55	32,86	75,92	152,12	238,59
300 mm	29,59	36,27	84,91	159,86	272,79
350 mm	--	41,16	88,91	166,75	306,99
400 mm	--	45,08	93,18	177,66	341,19

piega-bend-pivotée-Verdrehung-plega: 45° - 90° - 180° - **PREZZO - PRICE : +15%**

H-VERT



Ganci in acciaio per verniciatura in verticale di profili in alluminio.



Steel hooks for vertical painting of Aluminium profiles.

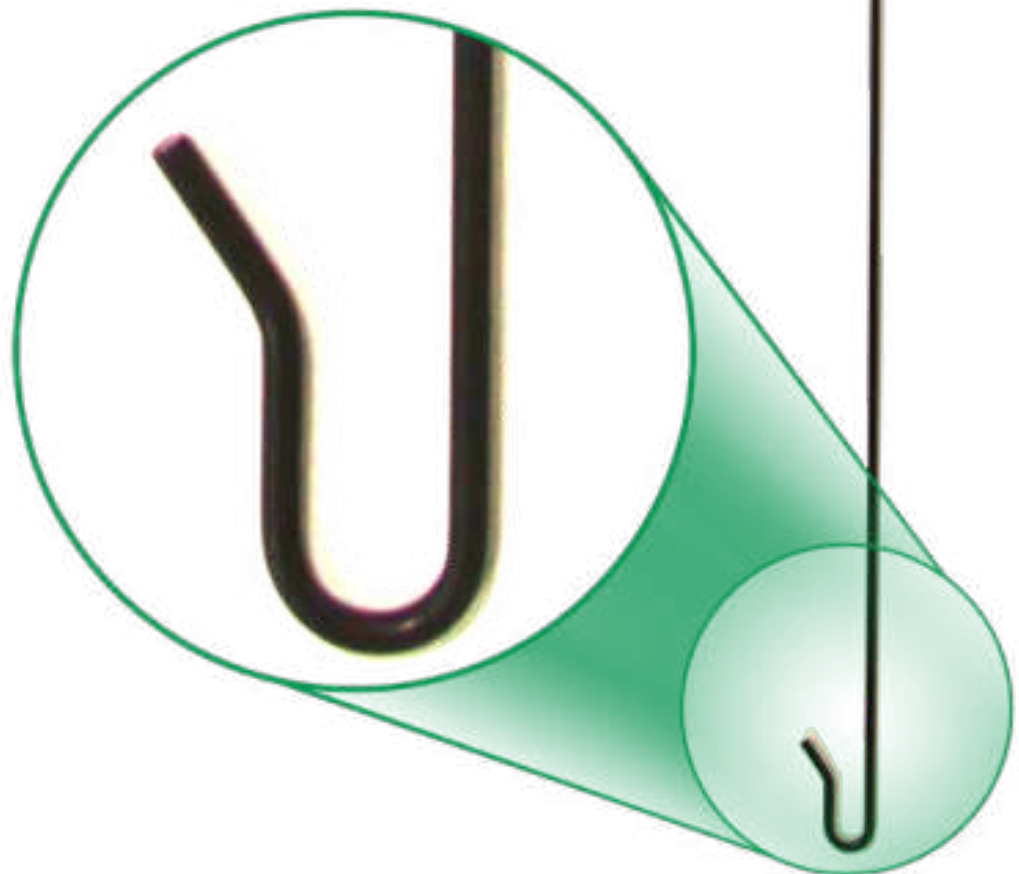

Articoli
vari



Ganci girevoli.



Swivel hooks.

SW
SW

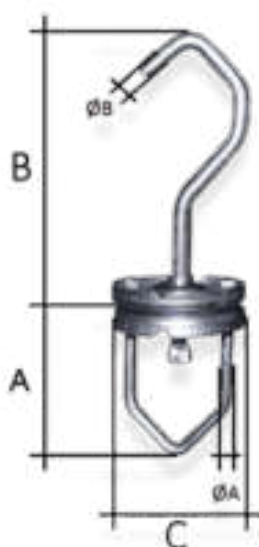

CODICE CODE	A	B	C	D	Ø A	Ø B	PREZZO CAD € PRICE EACH €
SW V	60	100	49,5	-	5	7	7,99
SW V CROWN	60	100	88	-	5	7	9,99
SW C	53	75	47,7	17,5	5	6	7,99

Ganci Speciali

Ganci Speciali



Ganci Speciali.

Produzione di grossi o piccoli volumi realizzati a disegno del cliente.
Rapidità di approntamento.
Adatti per verniciatura e saldatura.

Special Hooks.

Low or High volume quantities. Made on customer's bespoke drawings.
Fast turnaround.
Suitable for painting and welding.

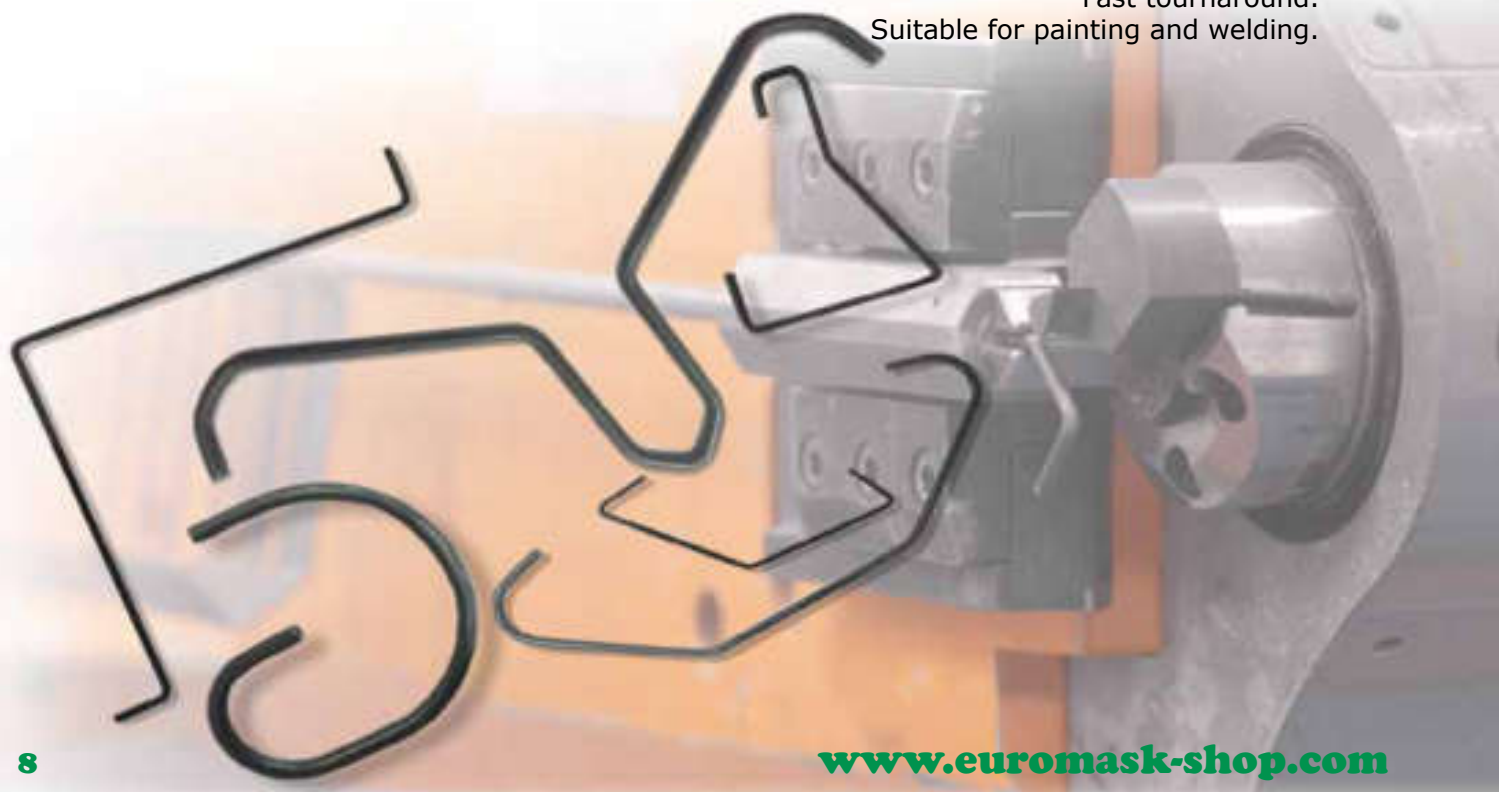

 **Distributore automatico taglianastro.**

 **Automatic tape-cut dispenser.**



CUT
CUT

Other
items

Taglio spezzoni da 20 a 999 mm di nastri adesivi larghi da 8 a 50 mm

To cut adhesive tape pieces from 20 to 999 mm LENGTH and from 8 to 50 mm width

CODICE CODE	PREZZO CAD € PRICE EACH €
CUT001	789,90

 **Termometri autoadesivi monouso.**
Graduati per controllo della temperatura all'interno del forno.

 **Self-adhesive thermometers (single-use).**
Graded for temperature control inside the oven.

TAI
TAI

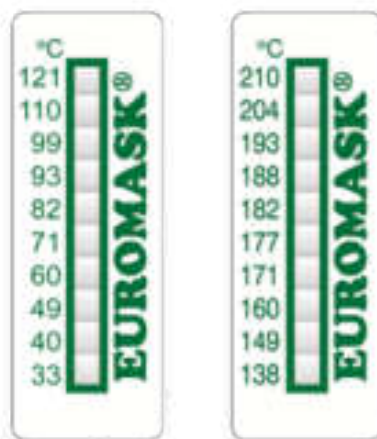

CODICE CODE	SCALA RANGE	PREZZO CAD € PRICE EACH €
TAI010 (10 pz)	138 °C - 210 °C	29,95
TAI009 (10 pz)	33°C - 121 °C	29,95



IT Stick per ritocco verniciatura a polvere.

EN Custom made touch-up pencils for powder coating

STICKRP01



CODICE CODE	PZ. SCAT. PCS. BOX	PREZZO/CAD € PRICE/EACH €
STICKRP01	fino a 50 PZ / up to 50 PCS	€ 13,00
STICKRP01	fino a 100 PZ / up to 100 PCS	€ 11,50
STICKRP01	fino a 250 PZ / up to 250 PCS	€ 10,00



Vernice spray HQS, studiata per il ritocco professionale.
Ampia gamma di colori RAL. Elevata durata nel tempo senza ingiallire,
senza cambiare colore e senza staccarsi dal materiale.



Spray paint HQS studied for professional retouching work.
Wide range of RAL colors. High long-time resistance without yellowing,
without changing color and without detaching from the material.



PRO^{PRO}



CODICE CODE	COLORI COLOURS	PZ. CONF. PCS. BOX	€/CONF. €/BOX
PRO	Colori vari RAL - Various RAL colours	6	€ 19,80
PROTRASP	Trasparente opaco o lucido - Glossy transparent or opaque	6	€ 19,80
PRO9006	Argento - Silver	6	€ 21,00
PRO-ANT	Antiruggine / Bianco / Grigio / Rosso Antirust / White / Grey / Rusty red	6	€ 21,00



Pellicola autoadesiva trasparente per protezione delle cabine di verniciatura a liquido.



Transparent self-adhesive film for protection of liquid spray booths.

AAP
AAP



CODICE CODE	ALTEZZA WIDTH	LUNGHEZZA LENGTH	PREZZO € PRICE €
AAP1970-250	500 mm	250 m	€ 147,00
AAP1575-250	400 mm	250 m	€ 117,60
AAP1180-250	300 mm	250 m	€ 88,20

IT **Nastro verde 204 °C.** Per rivestimenti a polvere e applicazioni di anodizzazione. Una volta rimosso lascia una superficie pulita, senza residui di adesivo. 0,05 mm di poliestere, 0,04 mm di adesivo in gomma.

EN **Green tape 204 °C.** Powder coating and anodizing applications. Clean removal, no adhesive residue. 0,05 mm polyester, 0,04 mm rubber adhesive.



NEW!
RPT
RPT
66mts

Altezze realizzabili
a richiesta
SENZA COSTI AGGIUNTIVI
Sizes on demand
with no additional cost



**SILICONE
FREE**

SERVIZIO DI TAGLIO NASTRO CON MISURE A RICHIESTA
ALTEZZE DISPONIBILI DA 3 A 1105 mm CON PASSO 1 mm

Nastri



Nastro verde 204 °C, lunghezza 250 m. Per rivestimenti a polvere e applicazioni di anodizzazione. Una volta rimosso lascia una superficie pulita, senza residui di adesivo. 0,05 mm di poliestere, 0,04 mm di adesivo.



Green tape 204 °C, length 250 m. Powder coating and anodizing applications. Clean removal, no adhesive residue. 0,05 mm polyester, 0,04 mm silicone adhesive.

EPTL
EPTL
250mts

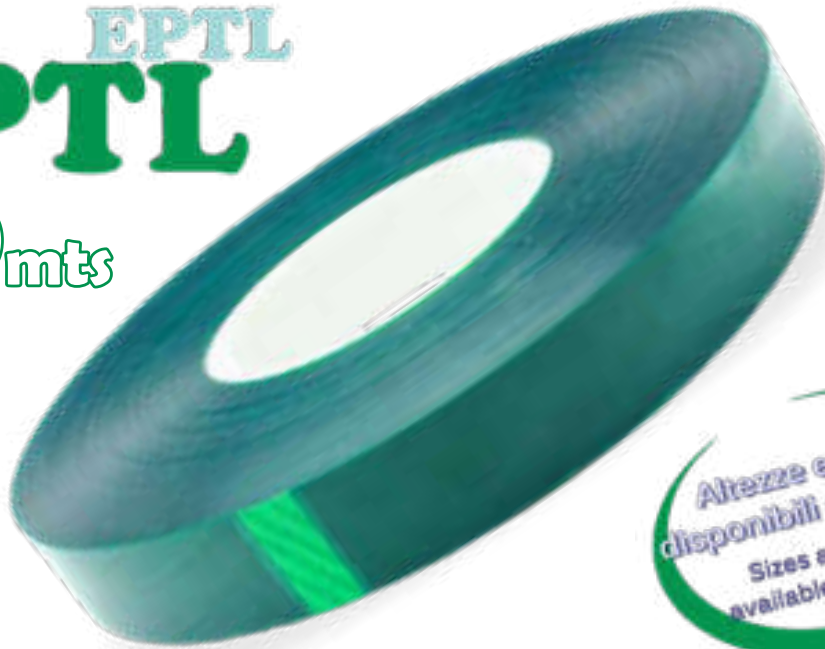

Altezze e prezzi
disponibili a richiesta
Sizes and prices
available on demand



Nastro verde 204 °C. Per rivestimenti a polvere e applicazioni di anodizzazione. Una volta rimosso lascia una superficie pulita, senza residui di adesivo. 0,05 mm di poliestere, 0,04 mm di adesivo.



Green tape 204 °C. Powder coating and anodizing applications. Clean removal, no adhesive residue. 0,05 mm polyester, 0,04 mm silicone adhesive.

HPT
HPT
55mts

Altre altezze
realizzabili a richiesta
senza costi aggiuntivi
Other sizes on demand
with no additional cost



SERVIZIO DI TAGLIO NASTRO CON MISURE A RICHIESTA
ALTEZZE DISPONIBILI DA 3 A 1105 mm CON PASSO 1 mm



Nastro rosso 220 °C. Per rivestimenti a polvere e applicazioni di anodizzazione. Una volta rimosso lascia una superficie pulita, senza residui di adesivo. 0,025 mm di poliestere, 0,07 mm di adesivo.



Red tape 220 °C. Powder coating and anodizing applications. Clean removal, no adhesive residue. 0,025 mm polyester, 0,07 mm silicone adhesive.

Altre altezze realizzabili a richiesta senza costi aggiuntivi
Other sizes on demand with no additional cost



EPR
EPR
66mts



SERVIZIO DI TAGLIO NASTRO CON MISURE A RICHIESTA
ALTEZZE DISPONIBILI DA 3 A 1105 mm CON PASSO 1 mm



Nastro blu 204 °C. Per rivestimenti a polvere e applicazioni di anodizzazione. Adatto per superfici curve. Una volta rimosso lascia una superficie pulita, senza residui di adesivo. 0,025 mm di poliestere, 0,05 mm di adesivo.



Blue tape 204 °C. Powder coating and anodizing applications. Adapted to curved surfaces. Clean removal, no adhesive residue. 0,025 mm polyester, 0,05 mm silicone adhesive.

Altre altezze realizzabili a richiesta senza costi aggiuntivi
Other sizes on demand with no additional cost



EPB
EPB
66mts

SERVIZIO DI TAGLIO NASTRO CON MISURE A RICHIESTA
ALTEZZE DISPONIBILI DA 3 A 1105 mm CON PASSO 1 mm

Nastri



Nastro trasparente 204 °C. Per rivestimenti a polvere e applicazioni di anodizzazione. Adatto per superfici curve. Una volta rimosso lascia una superficie pulita, senza residui di adesivo. 0,025 mm di poliestere, 0,04 mm di adesivo.



Clear tape 204 °C. Powder coating and anodizing applications. Adapted to curved surfaces. Clean removal, no adhesive residue. 0,025 mm polyester, 0,04 mm silicone adhesive.

STC
STC
66mts



Altre altezze realizzabili a richiesta senza costi aggiuntivi
Other sizes on demand with no additional cost

SERVIZIO DI TAGLIO NASTRO CON MISURE A RICHIESTA
ALTEZZE DISPONIBILI DA 3 A 1105 mm CON PASSO 1 mm



Nastro trasparente 204 °C. Per rivestimenti a polvere e applicazioni di anodizzazione. Una volta rimosso lascia una superficie pulita, senza residui di adesivo. 0,05 mm di poliestere, 0,04 mm di adesivo.



Clear tape 204 °C. Powder coating and anodizing applications. Clean removal, no adhesive residue. 0,05 mm polyester, 0,04 mm silicone adhesive.

CLT
CLT
66mts



Altre altezze realizzabili a richiesta senza costi aggiuntivi
Other sizes on demand with no additional cost

SERVIZIO DI TAGLIO NASTRO CON MISURE A RICHIESTA
ALTEZZE DISPONIBILI DA 3 A 1105 mm CON PASSO 1 mm



Biadesivo siliconico per alte temperature 204 °C.

Per rivestimenti a polvere e applicazioni di anodizzazione.
Una volta rimosso lascia una superficie pulita, senza residui di adesivo.



Silicone double side tape for high temperature 204°C.

Powder coating and anodizing applications.
Clean removal, no adhesive residue.

11900PET
11900PET
50mts



SERVIZIO DI TAGLIO NASTRO CON MISURE A RICHIESTA
ALTEZZE DISPONIBILI DA 10 A 975 mm CON PASSO 1 mm



Nastro polimide 260 °C. Per rivestimenti a polvere ed elettrostatici per immersione liquida.

Una volta rimosso lascia una superficie pulita, senza residui di adesivo. Ottima resistenza chimica.
0,025 mm di polimide, 0,04 mm di adesivo siliconico.



Polyimide tape 260 °C. Recommended for powder coating and E-coating. Clean removal,
no adhesive residue. Excellent chemical resistance. 0,025 mm polyimide, 0,04 mm silicone adhesive.



PC
PC
33mts



SERVIZIO DI TAGLIO NASTRO CON MISURE A RICHIESTA
ALTEZZE DISPONIBILI DA 3 A 1000 mm CON PASSO 1 mm

Nastri



Nastro in carta ad alta temperatura 190 °C.

Indicato per verniciatura a polvere. Lascia una superficie pulita senza residui.



High temperature masking tape 190 °C.

Recommended for powder coating. Clean removal.

SPG
SPG
50mts



Altre altezze
realizzabili a richiesta
senza costi aggiuntivi
Other sizes on demand
with no additional cost

SERVIZIO DI TAGLIO NASTRO CON MISURE A RICHIESTA
ALTEZZE DISPONIBILI DA 3 A 1230 mm CON PASSO 1 mm



Nastro per mascheratura 140 °C.

Indicato per verniciatura a liquido, lascia una superficie pulita senza residui.



Masking tape 140 °C.

Recommended for painting. Clean removal.

EPG
EPG
50mts



Altre altezze
realizzabili a richiesta
senza costi aggiuntivi
Other sizes on demand
with no additional cost

SERVIZIO DI TAGLIO NASTRO CON MISURE A RICHIESTA
ALTEZZE DISPONIBILI DA 3 A 1550 mm CON PASSO 1 mm



Nastro in tessuto di fibra di vetro 260 °C.

Indicato per la flammizzazione e per rivestimenti a polvere. Resistente alla sabbiatura ad alta pressione, all'abrasione e ai solventi.



Glass Cloth tape 260 °C.

Recommended for thermal spray and powder coating. Resistant to high pressure blasting, abrasion and to solvents.

Altre altezze realizzabili a richiesta senza costi aggiuntivi
Other sizes on demand with no additional cost

EGC
EGC
50mts



SERVIZIO DI TAGLIO NASTRO CON MISURE A RICHIESTA
ALTEZZE DISPONIBILI DA 3 A 1075 mm CON PASSO 1 mm



Nastro in carta per mascheratura 80°C.

Indicato per verniciatura a liquido a bassa temperatura, lascia la superficie pulita senza residui.



Semi crepe paper masking tape 80°C.

Recommended for liquid coating at low temperature. Good adhesion on irregular surfaces and no adhesive residual.

Altre altezze realizzabili a richiesta senza costi aggiuntivi
Other sizes on demand with no additional cost

LPG
LPG
50mts



SERVIZIO DI TAGLIO NASTRO CON MISURE A RICHIESTA
ALTEZZE DISPONIBILI DA 3 A 1410 mm CON PASSO 1 mm

Nastri



Nastro in alluminio 165 °C.

Spessore 65µ. Accoppiato con liner in carta. Con adesivo acrilico ad alte prestazioni. Indicato per applicazioni elettriche e termiche. Ottima resistenza alla flammatura.



Aluminium tape 165 °C.

65µ tape Aluminium. coupled with paper liner. With acrylic adhesive with high performance. Particularly suitable for electrical and thermal applications. Good flame hardening resistant.

Altre altezze realizzabili a richiesta senza costi aggiuntivi
Other sizes on demand with no additional cost

LALL65

50mts



SERVIZIO DI TAGLIO NASTRO CON MISURE A RICHIESTA
ALTEZZE DISPONIBILI DA 10 A 1080 mm CON PASSO 1 mm



Nastro in alluminio accoppiato su carta siliconata 165 °C.

Spessore 70µ. Con adesivo acrilico ad alte prestazioni. Indicato per applicazioni elettriche e termiche.



Aluminium tape on white silicone paper liner 165 °C.

70µ tape Aluminium. PET laminated with acrylic adhesive with high performance. Particularly suitable for electrical and thermal applications.

Altre altezze realizzabili a richiesta senza costi aggiuntivi
Other sizes on demand with no additional cost

LALL70

100mts



SERVIZIO DI TAGLIO NASTRO CON MISURE A RICHIESTA
ALTEZZE DISPONIBILI DA 10 A 1400 mm CON PASSO 1 mm



Nastro Fine Line Tape

Nastro in pvc con adesivo in gomma. Resistente al calore fino a 155°C. Indicato per lavorazioni complesse per la sua conformabilità.



High Temperature Fine Line Tape

PVC film with rubber adhesive, high conformability and a smooth, sharp mask-off edge. The blended rubber based adhesive system offers high temperature resistance up to 155°C.



Altre altezze realizzabili a richiesta senza costi aggiuntivi
Other sizes on demand with no additional cost



FLT
33mts

SERVIZIO DI TAGLIO NASTRO CON MISURE A RICHIESTA
ALTEZZE DISPONIBILI DA 3 A 1200 mm CON PASSO 1 mm



Nastro silicone autoagglomerante.

Nastro in silicone senza adesivo. Il nastro fondendosi su se stesso forma una pellicola omogenea resistente fino a 300 °C. Il nastro ha tempi di stoccaggio limitati.



Self-agglomerating silicone rubber tape.

Silicone rubber tape without adhesive. The tape vulcanized on itself, forms an homogeneous cover that can withstand temperatures of up to 300°C. Limited shelf life.



SRT
15mts

CODICE CODE	ALTEZZA SIZE	LUNGH. LENGTH	PZ. SCAT. RLS BOX	€/ROT. €/ROLL	€/SCAT. (CAD.) €/BOX (EACH)
SRT25	25 mm	15 m	20	44,19	35,35

PRICE LIST
€/ROLL

Nastri



ALTEZZA SIZE	RPT 66 m €/ROL	HPT 55 m €/ROLL	CLT 66 m €/ROLL	EPR 66 m €/ROLL	EPB 66 m €/ROLL	STC 66 m €/ROLL	11900PET 50 m €/ROLL
5 mm	3,60	2,07	2,63	4,37	3,83	2,75	13,09
10 mm	7,19	3,41	5,26	7,21	6,30	5,50	26,18
12 mm	8,63	4,13	6,31	8,72	7,63	6,60	31,42
15 mm	10,79	5,11	7,89	10,79	9,44	8,25	39,27
20 mm	14,38	6,82	10,51	14,40	12,61	11,00	52,36
25 mm	17,98	8,52	13,14	18,00	15,74	13,75	65,45
30 mm	21,57	10,23	15,77	21,60	18,91	16,50	78,54
35 mm	25,17	11,93	18,40	25,20	22,04	19,25	91,63
40 mm	28,76	13,63	21,03	28,79	25,19	22,00	104,72
45 mm	32,36	15,34	23,66	32,40	28,35	24,75	117,81
50 mm	35,95	17,04	26,29	35,99	31,49	27,50	130,90
80 mm	57,52	27,27	42,06	57,60	50,39	43,99	209,44
100 mm	71,90	34,09	52,57	72,00	63,00	54,99	261,80
150 mm	107,85	51,13	78,86	107,99	94,49	82,49	392,70

PRICE LIST
€/BOX



ALTEZZA SIZE	PZ. SCAT RLS BOX	RPT 66m €/BOX (EACH)	HPT 55 m €/BOX (EACH)	CLT 66 m €/BOX (EACH)	EPR 66 m €/BOX (EACH)	EPB 66 m €/BOX (EACH)	STC 66 m €/BOX (EACH)	11900PET 50 m €/BOX (EACH)
5 mm	150	2,88	1,55	2,10	3,50	3,06	2,20	10,47
10 mm	100	5,75	2,56	4,21	5,77	5,04	4,40	20,94
12 mm	80	6,90	3,10	5,05	6,98	6,10	5,28	25,14
15 mm	70	8,63	3,85	6,31	8,63	7,55	6,60	31,42
20 mm	50	11,50	5,11	8,41	11,52	10,09	8,80	41,89
25 mm	40	14,38	6,40	10,51	14,40	12,59	11,00	52,36
30 mm	40	17,26	7,67	12,62	17,28	15,13	13,20	62,83
35 mm	30	20,14	8,99	14,72	20,16	17,63	15,40	73,30
40 mm	30	23,01	10,23	16,82	23,03	20,15	17,60	83,78
45 mm	30	25,89	11,52	18,93	25,92	22,68	19,80	94,25
50 mm	30	28,76	12,78	21,03	28,79	25,19	22,00	104,72
80 mm	20	46,02	20,45	33,64	46,08	40,31	35,19	167,55
100 mm	10	57,52	25,56	42,06	57,60	50,40	43,99	209,44
150 mm	10	86,28	38,35	63,08	86,39	75,59	65,99	314,16



PC 33 m €/ROLL	EGC 50 m €/ROLL	SPG 50 m €/ROLL	EPG 50 m €/ROLL	LPG 50 m €/ROLL	FLT 33 m €/ROLL	LALL65 50 m €/ROLL	LALL70 100 m €/ROLL
2,68	6,19	2,73	2,27	0,65	5,45	4,09	9,00
5,36	12,36	3,91	3,24	0,93	7,78	5,84	12,87
6,43	14,84	4,69	3,89	1,12	9,34	7,01	15,44
8,04	18,55	5,87	4,86	1,40	11,67	8,76	19,31
10,72	24,73	7,82	6,48	1,86	15,56	11,68	25,74
13,40	30,91	9,78	8,10	2,33	19,45	14,60	32,18
16,08	37,09	11,73	9,72	2,79	23,34	17,52	38,61
18,76	43,27	13,69	11,34	3,26	27,23	20,44	45,05
21,43	49,45	15,64	12,96	3,72	31,12	23,36	51,48
24,12	55,64	17,60	14,58	4,19	35,01	26,28	57,92
26,80	61,81	19,55	16,20	4,65	38,90	29,20	64,35
42,86	98,90	31,28	25,92	7,44	62,24	46,72	102,96
53,58	123,63	39,10	32,40	9,30	77,80	58,40	128,70
80,38	185,44	58,65	48,60	13,95	116,70	87,60	193,05

Altre altezze
realizzabili a richiesta
senza costi aggiuntivi
Other sizes on demand
with no additional cost



PC 33 m €/BOX (EACH)	EGC 50 m €/BOX (EACH)	SPG 50 m €/BOX (EACH)	EPG 50 m €/BOX (EACH)	LPG 50 m €/BOX (EACH)	FLT 33 m €/BOX (EACH)	LALL65 50 m €/BOX (EACH)	LALL70 100 m €/ROLL (EACH)
2,14	4,95	2,18	1,82	0,52	4,36	3,27	7,20
4,29	9,89	3,13	2,59	0,74	6,22	4,67	10,30
5,14	11,87	3,75	3,11	0,90	7,47	5,61	12,35
6,43	14,84	4,70	3,89	1,12	9,34	7,01	15,45
8,58	19,78	6,26	5,18	1,49	12,45	9,34	20,59
10,72	24,73	7,82	6,48	1,86	15,56	11,68	25,74
12,86	29,67	9,38	7,78	2,23	18,67	14,02	30,89
15,01	34,62	10,95	9,07	2,61	21,78	16,35	36,04
17,14	39,56	12,51	10,37	2,98	24,90	18,69	41,18
19,30	44,51	14,08	11,66	3,35	28,01	21,02	46,34
21,44	49,45	15,64	12,96	3,72	31,12	23,36	51,48
34,29	79,12	25,02	20,74	5,95	49,79	37,38	82,37
42,86	98,90	31,28	25,92	7,44	62,24	46,72	102,96
64,30	148,35	46,92	38,88	11,16	93,36	70,08	154,44

Bollini

 Bollino adesivo con linguetta 204 °C.

 Adhesive discs with tab 204 °C.

EPCL EPCL



Altre dimensioni
realizzabili a richiesta
senza costi aggiuntivi
Other sizes on demand
with no additional cost

CODICE CODE	DIAM. mm DIAM mm	PZ ROLL PCS. ROLL	€/ROT. €/ROLL	€ 10 ROT. (CAD.) € 10 ROLLS (EACH)
EPCL15	15	2000	70,91	56,73
EPCL20	20	1000	53,19	42,55
EPCL25	25	500	37,67	30,14
EPCL30	30	500	49,54	39,63
EPCL45	45	500	96,99	77,59
EPCL50	50	250	57,62	46,09

REALIZZAZIONE BOLLINI CON DIAMETRI A RICHIESTA

 **Quadrati in nastro verde 204 °C.**

 **Squares green tape 204 C°.**

Altre dimensioni
realizzabili a richiesta
senza costi aggiuntivi
Other sizes on demand
with no additional cost



CODICE CODE	DIMENS. mm SIZES mm	PZ ROLL PCS. ROLL	€/ROT. €/ROLL	€ 10 ROT. (CAD.) € 10 ROLLS (EACH)
QPL5x5	5x5	1000	6,63	5,31
QPL10x10	10x10	1000	12,32	9,85
QPL50x50	50x50	1000	142,77	114,22
QPL100x100	100x100	250	91,84	73,48
QPL150x150	150x150	100	77,47	61,98

REALIZZAZIONE QUADRATI ADESIVI CON MISURE A RICHIESTA FINO A LATO 500 mm

 **Rettangoli in nastro verde 204 °C.**

 **Rectangles green tape 204 °C.**

Altre dimensioni
realizzabili a richiesta
senza costi aggiuntivi
Other sizes on demand
with no additional cost



CODICE CODE	DIMENS. (mm) SIZES (mm)	PZ ROLL PCS. ROLL	€/ROT. €/ROLL	€ 10 ROT. (CAD.) € 10 ROLLS (EACH)
RPL5X10	5X10	1000	9,24	7,39
RPL10x50	10X50	1000	47,42	37,94
RPL25x100	25x100	1000	150,89	120,71
RPL50x150	50x150	1000	339,41	271,53
RPL100x200	100x200	100	101,00	80,80

REALIZZAZIONE RETTANGOLI ADESIVI CON MISURE A RICHIESTA FINO A LATI 500x1000 mm

Bollini



Dischi adesivi per rivestimenti in polvere in nastro 204 °C.

Per rivestimenti in polvere e applicazioni di anodizzazione.
Una volta rimosso lascia una superficie pulita, senza residui di adesivo.



Powder Peel Discs. Green tape 204 °C.

Powder coating and anodizing applications. Clean removal, no adhesive residue.

EPC
EPC

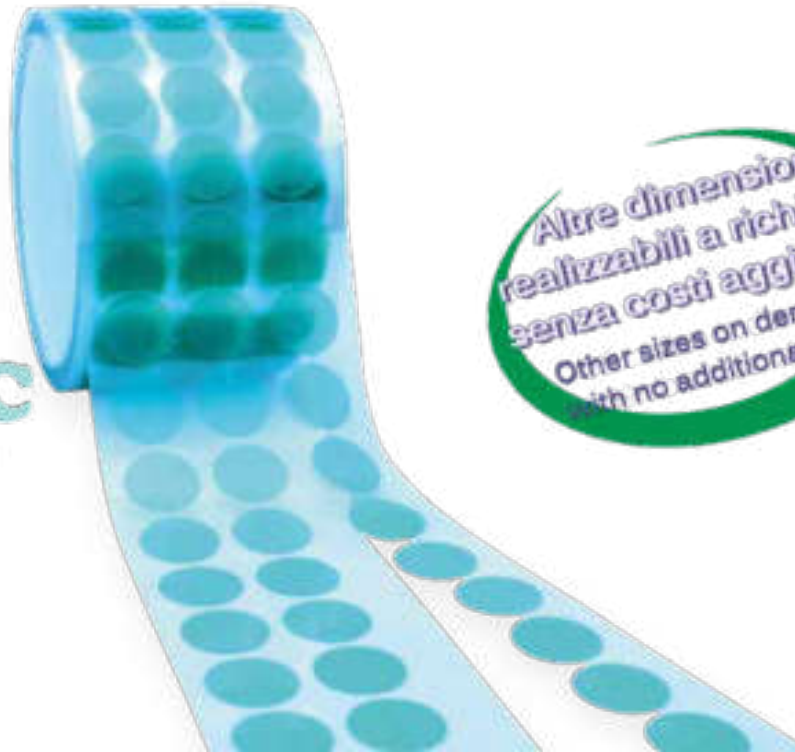

Altre dimensioni
realizzabili a richiesta
senza costi aggiuntivi
Other sizes on demand
with no additional cost

REALIZZAZIONE BOLLINI CON DIAMETRI A RICHIESTA



Bollini adesivi trasparenti 204°C.

Per rivestimenti in polvere e applicazioni di anodizzazione.
Una volta rimossi lasciano la superficie pulita, senza residui di adesivo. 0,025 mm di poliestere, 0,04 mm di adesivo



Clear tape disc 204 °C.

Powder coating and anodizing applications. Clean removal, no adhesive residue.
0,025 mm polyester, 0,04 mm silicone adhesive.

CLD
CLD



Altre dimensioni
realizzabili a richiesta
senza costi aggiuntivi
Other sizes on demand
with no additional cost

REALIZZAZIONE BOLLINI CON DIAMETRI A RICHIESTA



Dischi adesivi polimide 260 °C.

Per rivestimenti in polvere ed elettrostatici per immersione liquida. Una volta rimosso lascia una superficie pulita, senza residui di adesivo. Ottima resistenza chimica.



Polyimide powder peel disks 260 °C. Recommended for powder coating and E-coating. Clean removal, no adhesive residue. Excellent chemical resistance.



BPC
BPC

Altre dimensioni realizzabili a richiesta senza costi aggiuntivi
Other sizes on demand with no additional cost

REALIZZAZIONE BOLLINI CON DIAMETRI A RICHIESTA



Dischi adesivi in nastro blu 204 °C.



Blue ribbon adhesive disks 204 °C.

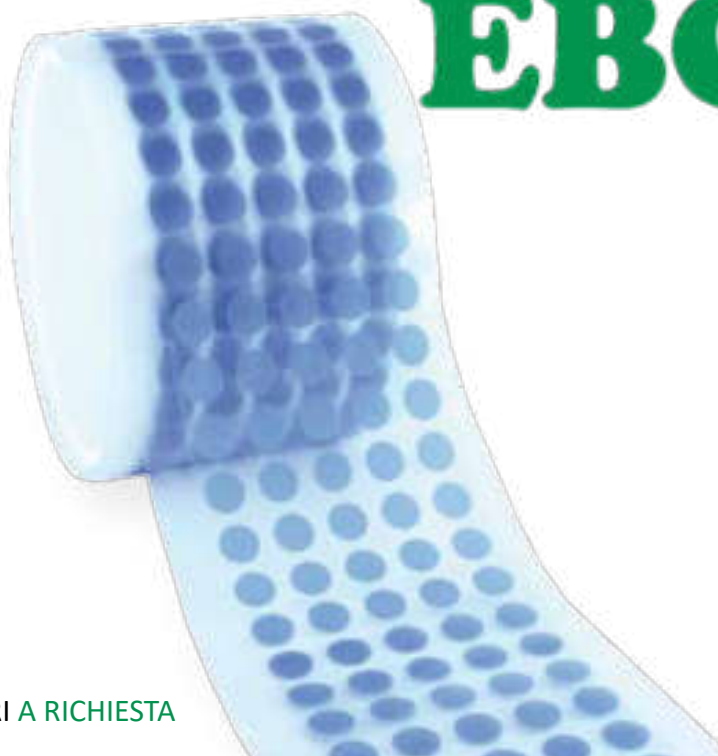

EBC
EBC

Altre dimensioni realizzabili a richiesta senza costi aggiuntivi
Other sizes on demand with no additional cost

REALIZZAZIONE BOLLINI CON DIAMETRI A RICHIESTA

Bollini



Bollini adesivi in vinile

Realizzati con adesivo acrilico removibile, permettono lunghi tempi di adesione prima del distacco. Utilizzati anche come protezione in movimentazione ed in verniciatura a liquido fino a 100°C.



White vinyl adhesive discs.

Made with acrylic removable adhesive, they are useful for different purpose and for applications that need long term peel. Excellent also in liquid coating up to 100°C.

EBV



Altre dimensioni
realizzabili a richiesta
senza costi aggiuntivi
Other sizes on demand
with no additional cost

REALIZZAZIONE BOLLINI CON DIAMETRI A RICHIESTA



Dischi adesivi in alluminio.

Spessore 65µ. Con adesivo acrilico ad alte prestazioni. Indicato per applicazioni elettriche e termiche. Ottima resistenza alla flammatura.



Aluminium tape discs.

65µ tape Aluminium discs with acrylic adhesive with high performance. Particularly suitable for electrical and thermal applications. Good flame hardening resistant.

ALUD



Altre dimensioni
realizzabili a richiesta
senza costi aggiuntivi
Other sizes on demand
with no additional cost

REALIZZAZIONE BOLLINI CON DIAMETRI A RICHIESTA



Bollini adesivi in carta per mascheratura 80°C.

Indicati per verniciatura a liquido a bassa temperatura, lasciano la superficie pulita senza residui.



Semi creped paper masking discs 80°C.

Recommended for liquid coating at low temperature. Good adhesion on irregular surfaces and no adhesive residual.



ELT^{ELT}
ELT



Altre dimensioni
realizzabili a richiesta
senza costi aggiuntivi
Other sizes on demand
with no additional cost

REALIZZAZIONE BOLLINI CON DIAMETRI A RICHIESTA



Bollini adesivi per mascheratura 140 °C.

Indicati per verniciatura a liquido, lasciano una superficie pulita (senza residui).



Masking discs 140 °C.

Recommended for painting. Clean removal.

EHT^{EHT}
EHT



Altre dimensioni
realizzabili a richiesta
senza costi aggiuntivi
Other sizes on demand
with no additional cost

REALIZZAZIONE BOLLINI CON DIAMETRI A RICHIESTA



Ø mm Ø mm	PZ. ROT. PCS. ROLL	EPC €/ROLL	EPC €/10 ROLLS (EACH)	CLD €/ROLL	CLD €/10 ROLLS (EACH)	BPC €/ROLL	BPC €/10 ROLLS (EACH)	EBC €/ROLL	EBC €/10 ROLLS (EACH)
3	2000	8,45	6,76	8,67	6,94	9,63	7,71	8,67	6,94
4	2000	9,36	7,49	11,15	8,92	12,39	9,91	10,84	8,67
5	2000	12,45	9,96	12,39	9,91	13,76	11,01	13,55	10,84
6	2000	14,29	11,43	15,90	12,72	17,66	14,13	17,03	13,63
7	2000	16,86	13,49	20,81	16,65	23,12	18,50	18,58	14,87
8	2000	17,35	13,88	22,55	18,04	25,05	20,04	23,49	18,79
9	2000	21,81	17,45	24,28	19,42	26,98	21,58	25,29	20,23
10	2000	23,13	18,50	32,52	26,01	36,13	28,90	32,52	26,01
11	2000	26,26	21,01	34,69	27,75	38,54	30,83	32,52	26,01
12	2000	28,93	23,14	36,85	29,48	40,95	32,76	34,55	27,64
13	2000	31,80	25,44	52,03	41,62	57,81	46,25	45,73	36,58
14	2000	36,96	29,57	54,92	43,94	61,02	48,82	48,27	38,61
15	2000	39,60	31,68	57,81	46,25	64,23	51,39	50,81	40,65
16	2000	43,11	34,49	49,66	39,73	55,18	44,15	58,20	46,56
17	1000	23,81	19,05	26,01	20,81	28,90	23,12	30,49	24,39
18	1000	25,05	20,04	34,00	27,20	37,77	30,22	31,87	25,50
19	1000	26,29	21,03	35,47	28,38	39,42	31,53	33,26	26,61
20	1000	27,48	21,98	36,95	29,56	41,06	32,85	34,64	27,71
21	1000	28,72	22,98	38,43	30,74	42,70	34,16	42,39	33,91
22	500	17,83	14,26	19,95	15,96	22,17	17,74	22,01	17,61
23	500	18,48	14,78	27,59	22,07	30,66	24,53	22,82	18,26
24	500	19,81	15,85	28,58	22,86	31,75	25,40	23,64	18,91
25	500	21,92	17,54	29,56	23,65	32,85	26,28	24,45	19,56
26	500	22,98	18,38	30,55	24,44	33,94	27,15	25,27	20,21
27	500	24,04	19,23	31,53	25,23	35,04	28,03	34,78	27,82
28	500	24,14	19,31	32,52	26,01	36,13	28,90	35,87	28,69
29	500	24,54	19,63	33,50	26,80	37,23	29,78	36,95	29,56
30	500	24,93	19,94	34,49	27,59	38,32	30,66	35,93	28,74
31	500	30,99	24,79	35,47	28,38	39,42	31,53	36,95	29,56
32	500	30,78	24,62	36,46	29,17	40,51	32,41	37,98	30,38
33	500	33,36	26,69	37,44	29,96	41,61	33,28	39,00	31,20
34	500	35,86	28,69	46,12	36,89	51,24	40,99	48,04	38,43
35	500	37,16	29,73	47,30	37,84	52,55	42,04	49,27	39,42
36	500	47,28	37,82	48,48	38,78	53,87	43,09	50,50	40,40
37	500	39,54	31,63	49,66	39,73	55,18	44,15	51,73	41,39
38	500	48,02	38,42	50,85	40,68	56,50	45,20	52,96	42,37
39	500	48,02	38,42	52,03	41,62	57,81	46,25	54,20	43,36
40	500	49,28	39,42	53,21	42,57	59,12	47,30	55,43	44,34
41	500	51,74	41,39	63,46	50,77	70,51	56,41	66,10	52,88
42	500	54,49	43,59	64,84	51,87	72,04	57,63	67,54	54,03
43	500	52,98	42,38	66,22	52,97	73,58	58,86	68,98	55,18
44	500	58,37	46,70	67,60	54,08	75,11	60,09	70,41	56,33
45	500	59,70	47,76	68,98	55,18	76,64	61,31	71,85	57,48
46	250	31,09	24,87	35,18	28,14	39,09	31,27	36,64	29,32
47	250	32,94	26,35	35,87	28,69	39,85	31,88	37,36	29,89
48	250	34,30	27,44	36,56	29,25	40,62	32,50	38,08	30,46
49	250	27,70	22,16	37,25	29,80	41,39	33,11	38,80	31,04
50	250	35,04	28,03	40,65	32,52	45,16	36,13	40,11	32,09
51	250	37,72	30,18	41,39	33,11	45,98	36,79	40,84	32,67
52	250	38,40	30,72	42,13	33,70	46,81	37,44	41,57	33,26
53	250	39,38	31,50	42,86	34,29	47,63	38,10	42,30	33,84

REALIZZAZIONE BOLLINI CON DIAMETRI A RICHIESTA



EBV €/ROLL	EBV €/10 ROLLS (EACH)	ALUD €/ROLL	ALUD €/10 ROLLS (EACH)	ELT €/ROLL	ELT €/10 ROLLS (EACH)	EHT €/ROLL	EHT €/10 ROLLS (EACH)	PZ. ROT. PCS. ROLL	Ø mm Ø mm
2,17	1,73	4,22	3,37	2,65	2,12	5,78	4,62	2000	3
2,79	2,23	5,42	4,34	3,41	2,73	7,43	5,95	2000	4
3,10	2,48	6,02	4,82	3,79	3,03	8,26	6,61	2000	5
3,97	3,18	7,73	6,18	4,86	3,89	10,60	8,48	2000	6
5,20	4,16	10,12	8,09	6,36	5,09	13,87	11,10	2000	7
5,64	4,51	10,96	8,77	6,89	5,51	15,03	12,02	2000	8
6,07	4,86	11,80	9,44	7,42	5,94	16,19	12,95	2000	9
8,13	6,50	15,81	12,65	9,94	7,95	21,68	17,34	2000	10
8,67	6,94	16,86	13,49	10,60	8,48	23,12	18,50	2000	11
9,21	7,37	17,91	14,33	11,26	9,01	24,57	19,66	2000	12
13,01	10,41	25,29	20,23	15,90	12,72	34,69	27,75	2000	13
13,73	10,98	26,70	21,36	16,78	13,42	36,61	29,29	2000	14
14,45	11,56	28,10	22,48	17,66	14,13	38,54	30,83	2000	15
12,42	9,93	24,14	19,31	15,17	12,14	33,11	26,49	2000	16
6,50	5,20	12,65	10,12	7,95	6,36	17,34	13,87	1000	17
8,50	6,80	16,53	13,22	10,39	8,31	22,66	18,13	1000	18
8,87	7,09	17,24	13,80	10,84	8,67	23,65	18,92	1000	19
9,24	7,39	17,96	14,37	11,29	9,03	24,63	19,71	1000	20
9,61	7,69	18,68	14,95	11,74	9,39	25,62	20,50	1000	21
4,99	3,99	9,70	7,76	6,10	4,88	13,30	10,64	500	22
6,90	5,52	13,41	10,73	8,43	6,74	18,39	14,72	500	23
7,14	5,72	13,89	11,11	8,73	6,99	19,05	15,24	500	24
7,39	5,91	14,37	11,50	9,03	7,23	19,71	15,77	500	25
7,64	6,11	14,85	11,88	9,33	7,47	20,36	16,29	500	26
7,88	6,31	15,33	12,26	9,63	7,71	21,02	16,82	500	27
8,13	6,50	15,81	12,65	9,94	7,95	21,68	17,34	500	28
8,38	6,70	16,29	13,03	10,24	8,19	22,34	17,87	500	29
8,62	6,90	16,77	13,41	10,54	8,43	22,99	18,39	500	30
8,87	7,09	17,24	13,80	10,84	8,67	23,65	18,92	500	31
9,11	7,29	17,72	14,18	11,14	8,91	24,31	19,44	500	32
9,36	7,49	18,20	14,56	11,44	9,15	24,96	19,97	500	33
11,53	9,22	22,42	17,93	14,09	11,27	30,74	24,60	500	34
11,82	9,46	22,99	18,39	14,45	11,56	31,53	25,23	500	35
12,12	9,70	23,57	18,85	14,81	11,85	32,32	25,86	500	36
12,42	9,93	24,14	19,31	15,17	12,14	33,11	26,49	500	37
12,71	10,17	24,72	19,77	15,54	12,43	33,90	27,12	500	38
13,01	10,41	25,29	20,23	15,90	12,72	34,69	27,75	500	39
13,30	10,64	25,87	20,69	16,26	13,01	35,47	28,38	500	40
15,86	12,69	30,85	24,68	19,39	15,51	42,31	33,84	500	41
16,21	12,97	31,52	25,21	19,81	15,85	43,23	34,58	500	42
16,55	13,24	32,19	25,75	20,23	16,19	44,15	35,32	500	43
16,90	13,52	32,86	26,29	20,65	16,52	45,06	36,05	500	44
17,24	13,80	33,53	26,82	21,08	16,86	45,98	36,79	500	45
8,79	7,04	17,10	13,68	10,75	8,60	23,45	18,76	250	46
8,97	7,17	17,44	13,95	10,96	8,77	23,91	19,13	250	47
9,14	7,31	17,77	14,22	11,17	8,94	24,37	19,50	250	48
9,31	7,45	18,11	14,49	11,38	9,10	24,83	19,87	250	49
10,16	8,13	19,76	15,81	12,42	9,94	27,10	21,68	250	50
10,35	8,28	20,12	16,09	12,65	10,12	27,59	22,07	250	51
10,53	8,43	20,48	16,38	12,87	10,30	28,08	22,47	250	52
10,72	8,57	20,84	16,67	13,10	10,48	28,58	22,86	250	53

Ø mm Ø mm	PZ. ROT. PCS. ROLL	EPC €/ROLL	EPC €/10 ROLLS (EACH)	CLD €/ROLL	CLD €/10 ROLLS (EACH)	BPC €/ROLL	BPC €/10 ROLLS (EACH)	EBC €/ROLL	EBC €/10 ROLLS (EACH)
54	250	41,38	33,10	43,60	34,88	48,45	38,76	43,03	34,42
55	250	41,38	33,10	47,30	37,84	52,55	42,04	46,68	37,34
56	250	42,13	33,70	48,09	38,47	53,43	42,74	47,45	37,96
57	250	42,88	34,30	48,88	39,10	54,31	43,44	48,23	38,59
58	250	43,10	34,48	49,66	39,73	55,18	44,15	49,01	39,21
59	250	43,79	35,03	50,45	40,36	56,06	44,85	49,79	39,83
60	250	44,76	35,81	57,65	46,12	64,05	51,24	56,89	45,51
61	250	44,93	35,94	58,53	46,83	65,04	52,03	57,76	46,21
62	250	45,61	36,49	59,42	47,53	66,02	52,82	58,64	46,91
63	250	47,00	37,60	60,31	48,24	67,01	53,60	59,51	47,61
64	250	48,51	38,81	61,19	48,95	67,99	54,39	60,39	48,31
65	250	49,32	39,46	62,08	49,66	68,98	55,18	61,26	49,01
66	250	50,30	40,24	62,97	50,37	69,96	55,97	62,14	49,71
67	250	51,60	41,28	63,85	51,08	70,95	56,76	63,01	50,41
68	250	51,60	41,28	64,74	51,79	71,93	57,55	63,89	51,11
69	250	51,73	41,38	65,63	52,50	72,92	58,33	64,76	51,81
70	250	53,12	42,50	70,95	56,76	98,54	78,83	83,14	66,51
71	250	53,49	42,79	71,89	57,51	99,85	79,88	84,25	67,40
72	250	54,17	43,34	72,84	58,27	101,17	80,93	85,36	68,29
73	250	54,93	43,94	73,79	59,03	102,48	81,98	86,47	69,17
74	250	56,43	45,14	74,73	59,79	103,79	83,04	87,58	70,06
75	250	56,43	45,14	75,68	60,54	105,11	84,09	88,68	70,95
76	250	60,12	48,10	76,62	61,30	106,42	85,14	89,79	71,83
77	250	61,21	48,97	77,57	62,06	107,74	86,19	90,90	72,72
78	250	61,70	49,36	78,52	62,81	109,05	87,24	92,01	73,61
79	250	65,84	52,67	79,46	63,57	110,36	88,29	93,12	74,50
80	250	66,00	52,80	80,41	64,33	111,68	89,34	94,23	75,38
81	250	67,41	53,93	81,35	65,08	112,99	90,39	95,34	76,27
82	250	67,65	54,12	82,30	65,84	114,30	91,44	96,44	77,16
83	250	68,48	54,78	83,25	66,60	115,62	92,49	97,55	78,04
84	250	69,76	55,81	84,19	67,35	116,93	93,55	98,66	78,93
85	250	70,13	56,10	85,14	68,11	118,25	94,60	99,77	79,82
86	250	68,23	54,58	86,08	68,87	119,56	95,65	100,88	80,70
87	250	58,50	46,80	87,03	69,62	120,87	96,70	101,99	81,59
88	250	74,78	59,82	87,98	70,38	122,19	97,75	103,10	82,48
89	250	75,63	60,50	88,92	71,14	123,50	98,80	104,20	83,36
90	250	76,48	61,18	104,84	83,88	145,62	116,49	122,87	98,29
91	250	78,83	63,06	105,95	84,76	147,15	117,72	124,16	99,33
92	250	79,65	63,72	107,05	85,64	148,68	118,95	125,45	100,36
93	250	80,47	64,38	108,16	86,52	150,22	120,17	126,75	101,40
94	250	81,29	65,03	109,26	87,41	151,75	121,40	128,04	102,43
95	250	82,40	65,92	110,36	88,29	153,28	122,63	129,33	103,47
96	250	84,66	67,73	111,47	89,17	154,81	123,85	130,63	104,50
97	250	85,49	68,39	112,57	90,06	156,35	125,08	131,92	105,53
98	250	88,31	70,65	113,67	90,94	157,88	126,30	133,21	106,57
99	250	87,18	69,74	114,78	91,82	159,41	127,53	134,51	107,60
100	250	88,31	70,65	115,88	92,70	160,95	128,76	120,71	96,57
150	100	45,77	36,61	87,28	69,82	135,76	108,61	91,64	73,31
200	100	92,34	73,88	138,52	110,81	215,47	172,38	145,44	116,35
300	100	200,36	160,29	280,51	224,40	467,51	374,01	315,57	252,46
400	100	380,08	304,06	478,90	383,12	798,16	638,53	538,76	431,01
500	100	568,71	454,97	729,84	583,87	1216,40	973,12	821,07	656,86

REALIZZAZIONE BOLLINI CON DIAMETRI A RICHIESTA

EBV €/ROLL	EBV €/10 ROLLS (EACH)	ALUD €/ROLL	ALUD €/10 ROLLS (EACH)	ELT €/ROLL	ELT €/10 ROLLS (EACH)	EHT €/ROLL	EHT €/10 ROLLS (EACH)	PZ. ROT. PCS. ROLL	Ø mm Ø mm
10,90	8,72	21,20	16,96	13,32	10,66	29,07	23,26	250	54
11,82	9,46	22,99	18,39	14,45	11,56	31,53	25,23	250	55
12,02	9,62	23,38	18,70	14,69	11,75	32,06	25,65	250	56
12,22	9,78	23,76	19,01	14,93	11,95	32,58	26,07	250	56
12,42	9,93	24,14	19,31	15,17	12,14	33,11	26,49	250	58
12,61	10,09	24,53	19,62	15,42	12,33	33,63	26,91	250	59
14,41	11,53	28,02	22,42	17,61	14,09	38,43	30,74	250	60
14,63	11,71	28,45	22,76	17,88	14,31	39,02	31,22	250	61
14,85	11,88	28,88	23,11	18,16	14,52	39,61	31,69	250	62
15,08	12,06	29,32	23,45	18,43	14,74	40,20	32,16	250	63
15,30	12,24	29,75	23,80	18,70	14,96	40,79	32,64	250	64
15,52	12,42	30,18	24,14	18,97	15,17	41,39	33,11	250	65
15,74	12,59	30,61	24,49	19,24	15,39	41,98	33,58	250	66
15,96	12,77	31,04	24,83	19,51	15,61	42,57	34,05	250	67
16,18	12,95	31,47	25,18	19,78	15,83	43,16	34,53	250	68
16,41	13,13	31,90	25,52	20,05	16,04	43,75	35,00	250	69
22,17	17,74	43,11	34,49	27,10	21,68	59,12	47,30	250	70
22,47	17,97	43,69	34,95	27,46	21,97	59,91	47,93	250	71
22,76	18,21	44,26	35,41	27,82	22,26	60,70	48,56	250	72
23,06	18,45	44,84	35,87	28,18	22,55	61,49	49,19	250	73
23,35	18,68	45,41	36,33	28,54	22,83	62,28	49,82	250	74
23,65	18,92	45,98	36,79	28,90	23,12	63,06	50,45	250	75
23,94	19,16	46,56	37,25	29,27	23,41	63,85	51,08	250	76
24,24	19,39	47,13	37,71	29,63	23,70	64,64	51,71	250	77
24,54	19,63	47,71	38,17	29,99	23,99	65,43	52,34	250	78
24,83	19,87	48,28	38,63	30,35	24,28	66,22	52,97	250	79
25,13	20,10	48,86	39,09	30,71	24,57	67,01	53,60	250	80
25,42	20,34	49,43	39,55	31,07	24,86	67,79	54,24	250	81
25,72	20,57	50,01	40,01	31,43	25,15	68,58	54,87	250	82
26,01	20,81	50,58	40,47	31,80	25,44	69,37	55,50	250	83
26,31	21,05	51,16	40,93	32,16	25,73	70,16	56,13	250	84
26,61	21,28	51,73	41,39	32,52	26,01	70,95	56,76	250	85
26,90	21,52	52,31	41,85	32,88	26,30	71,74	57,39	250	86
27,20	21,76	52,88	42,31	33,24	26,59	72,52	58,02	250	87
27,49	21,99	53,46	42,77	33,60	26,88	73,31	58,65	250	88
27,79	22,23	54,03	43,23	33,96	27,17	74,10	59,28	250	89
32,76	26,21	63,71	50,97	40,04	32,04	87,37	69,90	250	90
33,11	26,49	64,38	51,50	40,47	32,37	88,29	70,63	250	91
33,45	26,76	65,05	52,04	40,89	32,71	89,21	71,37	250	92
33,80	27,04	65,72	52,58	41,31	33,05	90,13	72,10	250	93
34,14	27,31	66,39	53,11	41,73	33,38	91,05	72,84	250	94
34,49	27,59	67,06	53,65	42,15	33,72	91,97	73,58	250	95
34,83	27,87	67,73	54,19	42,57	34,06	92,89	74,31	250	96
35,18	28,14	68,40	54,72	43,00	34,40	93,81	75,05	250	97
35,52	28,42	69,07	55,26	43,42	34,73	94,73	75,78	250	98
35,87	28,69	69,74	55,79	43,84	35,07	95,65	76,52	250	99
36,21	28,97	70,41	56,33	44,26	35,41	96,57	77,25	250	100
30,55	24,44	59,40	47,52	37,34	29,87	81,46	65,17	100	150
48,48	38,78	94,27	75,41	59,25	47,40	129,28	103,43	100	200
105,19	84,15	204,54	163,63	128,57	102,85	280,51	224,40	100	300
179,59	143,67	349,20	279,36	243,88	195,11	532,11	425,69	100	400
273,69	218,95	532,18	425,74	364,92	291,94	796,19	636,95	100	500

Fustellati Speciali

Fustellati Speciali

Speciali



Fustellature di precisione.

Produzione di grossi o piccoli volumi. Vasta gamma di materiali. Rapidità di approntamento. Bassi costi di realizzazione impianto.



Engineered precision tape die-cut.

Low or high volume quantities. Wide variety of materials. Fast turnaround. Very reasonable tooling costs.

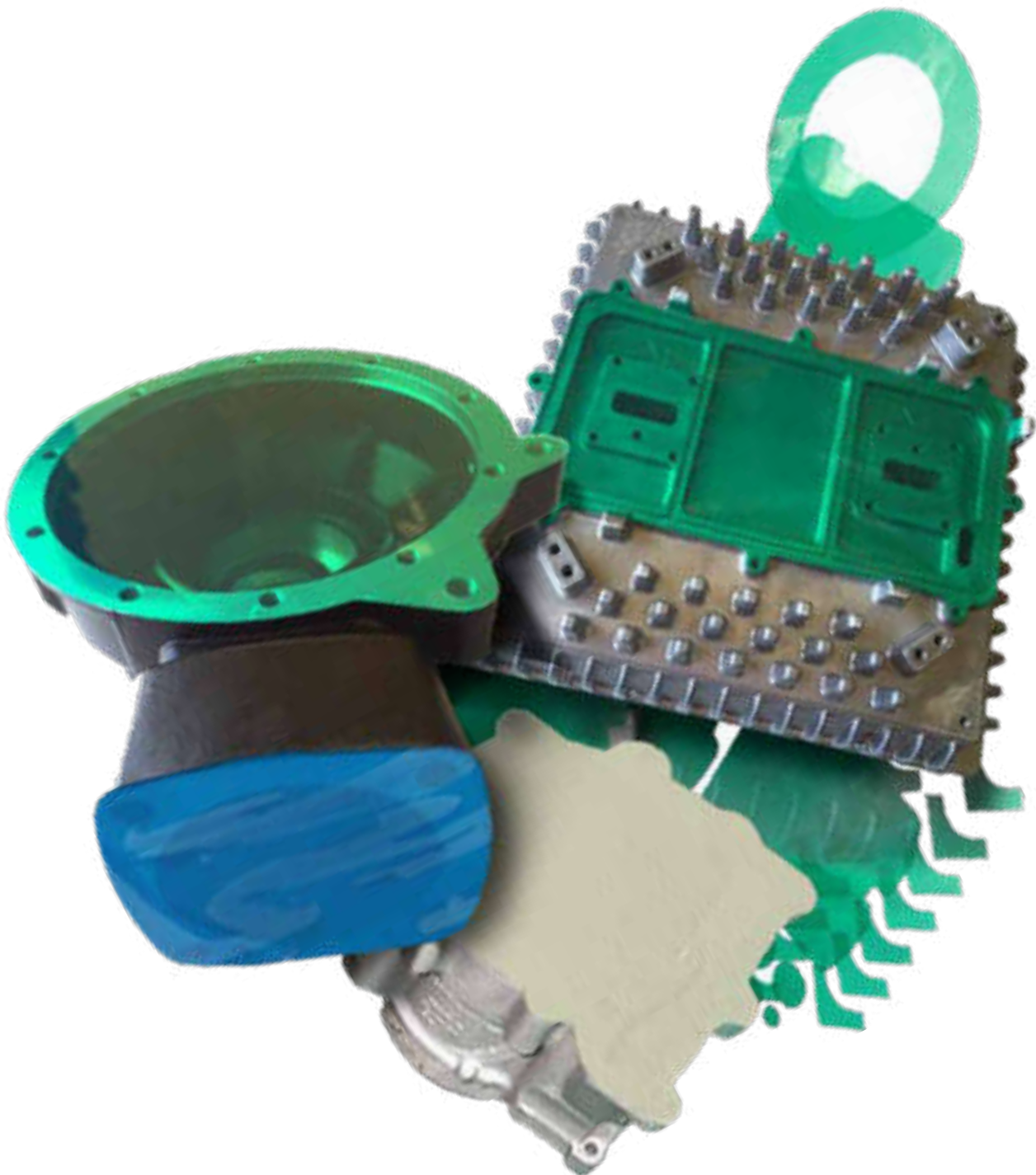

Stampati Speciali

Stampati Speciali

Special

IT Tappi e Cappucci stampati speciali.

Ampia varietà di materiali. Fornitura di campioni per l'approvazione del cliente prima di avviare la produzione.

Nel reparto tecnico di Euromask® lavorano persone esperte; tecnici capaci di disegnare, modellare e realizzare prototipi con velocità e precisione.

Con Euromask®:

- Studio del prototipo da disegno 2D/3D o direttamente dal pezzo.
- Bassissimi costi per la Fornitura dei campioni: tappi o cappucci per la verniciatura ed altri trattamenti superficiali.

Questo in 3 giorni, per geometrie molto complesse 5.

- Quando il Cliente approva, immediata messa in produzione.

Produciamo in proprio con tecnologie ed impianti moderni ed efficienti. Per i nostri Clienti questo significa costi contenuti e rapidità nella fornitura di grossi e piccoli quantitativi, in una vasta gamma di materiali.



Engineered Molded Products

Engineered Molded Products



Engineered molded plugs and caps.

Wide variety of materials. Samples always provided for your approval before production.

Skilled persons work in Euromask®'s department; technical experts able to draw, model and realize samples with precision and rapidity.

With Euromask®:

- Prototype analysis starting from 2D or 3D drawing, or directly from the item that need to be masked
- Low prototypes supply costs: plugs or caps for painting operations and other surface treatments.

This within 3 days, for more complex structures 5 days.

- When the customer approves, immediate production.

We produce directly on our own with modern and efficient technologies and plants. For our customers this means low prices and fast supply of large and small quantity of goods, with a wide range of materials available.

Tubi,
corde



Tubo cavo per rivestimenti in polvere 315 °C.

Indicato per rivestimenti in polvere e rivestimenti elettrostatici per immersione liquida.



Tubing for Powder Coating 315 °C.

Recommended for powder coating and E-coating.

EST

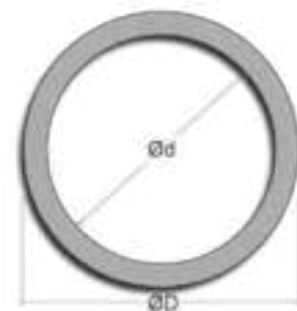

CODICE CODE	DIAM. INT. INT. DIAM	DIAM. EST. EXT DIAM	LUNGH. LENGTH	€/BOBINA €/COIL	€ 5 BOBINE (CAD.) € 5 COILS (EACH)
EST2	2 mm	4 mm	50 m	47,79	38,23
EST3	3 mm	5 mm	50 m	55,66	44,53
EST4	4 mm	6 mm	50 m	71,10	56,88
EST5	5 mm	7 mm	50 m	79,75	63,80
EST6	6 mm	8 mm	50 m	94,45	75,56
EST8	8 mm	10 mm	50 m	129,29	103,43
EST10	10 mm	12 mm	50 m	136,45	109,16
EST12	12 mm	15 mm	50 m	203,65	162,92
EST14	14 mm	16 mm	25 m	94,14	75,31
EST16	16 mm	22 mm	25 m	293,95	235,16
EST18	18 mm	22 mm	20 m	149,96	119,97
EST20	20 mm	24 mm	20 m	167,12	133,69
EST25	25 mm	33 mm	15 m	325,45	260,36
EST30	30 mm	40 mm	10 m	366,40	293,12

**Cordoncino pieno per rivestimenti in polvere 315 °C.**

Indicato per rivestimenti in polvere e rivestimenti elettrostatici per immersione liquida. Flessibile.

**Cord for Powder Coating 315 °C.**

Recommended for powder coating and E-coating. Flexible.

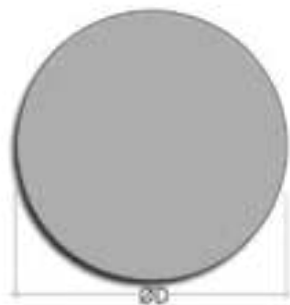
ETO
ETOTubings,
cords

CODICE CODE	DIAM. DIAM.	LUNGH. LENGTH	€/BOBINA €/COIL	€ 5 BOBINE (CAD.) € 5 COILS (EACH)
ETO3	3 mm	100 m	120,39	96,32
ETO4	4 mm	100 m	149,82	119,86
ETO5	5 mm	100 m	195,31	156,25
ETO6	6 mm	50 m	259,52	207,61
ETO7	7 mm	50 m	161,86	129,49
ETO8	8 mm	50 m	212,70	170,16
ETO9	9 mm	25 m	134,44	107,55
ETO10	10 mm	25 m	331,75	265,40
ETO11	11 mm	25 m	200,66	160,53
ETO12	12 mm	25 m	238,78	191,03
ETO13	13 mm	25 m	280,92	224,74
ETO14	14 mm	25 m	325,73	260,59
ETO15	15 mm	25 m	389,28	311,42
ETO16	16 mm	15 m	255,24	204,19
ETO18	18 mm	15 m	322,66	258,13
ETO20	20 mm	15 m	398,51	318,81

Tubi,
corde



Tubo a stella in silicone 315 °C.

La sua forma permette di utilizzarlo per i vari diametri.



Silicone star tube 315 °C.

Its shape allows to use it for various diameters.

EZT

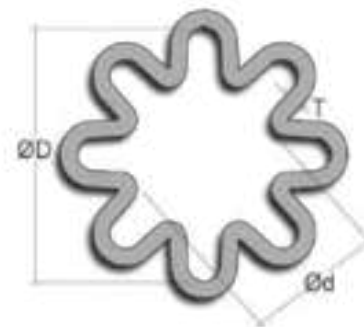

CODICE CODE	Ød	ØD	T	LUNGH. LENGTH	€/BOBINA €/COIL	€ 5 BOBINE (CAD.) € 5 COILS (EACH)
EZT3X5	2,80	5,30	1,52	30,48	110,78	88,62
EZT5X7	4,80	7,30	1,52	30,48	143,04	114,43
EZT6X6,5	5,08	6,35	1,52	30,48	127,70	102,16
EZT7X9	6,50	9,50	1,52	30,48	178,47	142,78
EZT8X9	7,62	9,53	1,52	30,48	178,85	143,08
EZT9X11	8,50	11,50	1,52	30,48	210,66	168,53
EZT10X12	10,16	12,70	1,52	30,48	230,00	184,00
EZT11X13	10,70	14,00	1,52	30,48	250,93	200,74
EZT13X17	12,50	18,00	1,52	30,48	315,30	252,24
EZT13X15	12,70	15,88	1,52	30,48	281,08	224,86
EZT15X18	15,88	19,05	1,52	15,24	166,61	133,29
EZT19X22	18,42	22,23	1,52	15,24	192,15	153,72
EZT22X25	21,59	25,40	1,52	15,24	217,76	174,21
EZT25X30	25,40	31,75	1,52	7,62	134,95	107,96
EZT32X38	31,75	38,10	1,52	7,62	160,49	128,39
EZT38X44	38,10	44,45	1,52	7,62	186,03	148,82
EZT44X50	44,45	50,80	1,52	7,62	211,64	169,31

 Corda in schiuma di silicone 220 °C.

 Silicone foam cord 220 °C.

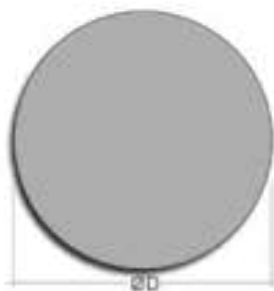

ASC
ASC

Tubings,
cords

CODICE CODE	DIAM. mm DIAM. mm	LUNGH. LENGTH	€/BOBINA €/COIL	€ 5 BOBINE (CAD.) € 5 COILS (EACH)
ASC020	2 mm	25 m	10,80	8,64
ASC030	3 mm	25 m	15,79	12,63
ASC040	4 mm	25 m	25,21	20,17
ASC050	5 mm	25 m	37,07	29,66
ASC060	6 mm	25 m	51,48	41,18
ASC070	7 mm	25 m	68,30	54,64
ASC080	8 mm	25 m	87,62	70,09
ASC090	9 mm	25 m	109,46	87,57
ASC100	10 mm	25 m	133,74	106,99
ASC120	12 mm	25 m	189,71	151,77
ASC160	16 mm	25 m	331,46	265,17
ASC180	18 mm	25 m	417,18	333,75
ASC200	20 mm	25 m	512,84	410,27
ASC250	25 mm	25 m	795,28	636,23
ASC300	30 mm	25 m	1139,72	911,78



QSC
QSC

CODICE CODE	SEZIONE	LUNGH. LENGTH	€/BOBINA €/COIL	€ 5 BOBINE (CAD.) € 5 COILS (EACH)
QSC 10 X 10	10 mm	25 m	154,79	123,83
QSC 12 X 12	12 mm	25 m	221,85	177,48
QSC 20 X 20	20 mm	25 m	612,22	489,77

Sagome speciali da taglio piano



Taglio Piano

Lavorazioni standard e a disegno su lastre da 2 a 15mm di spessore in silicone, EPDM, schiume a varia densità e materiali accoppiati.

Rapidità di campionatura e di produzione in 2/3 giorni in funzione della complessità delle sagome. Le forme realizzate soddisfano sia esigenze di trattamenti a polvere che a liquido creando sagome precise alla richiesta del cliente.





Shapes from knife cutting machine
Shapes from knife cutting machine

Special

Knife Cutting

Suitable for standard and bespoke shapes on Silicone, EPDM, Foams and sheets with liner from 2 to 15mm thickness.

Fast sampling and production in 2/3 days, depending on shape. All the materials and shapes created on customer's request are suitable for all the surface treatment, from liquid to powder coatings.

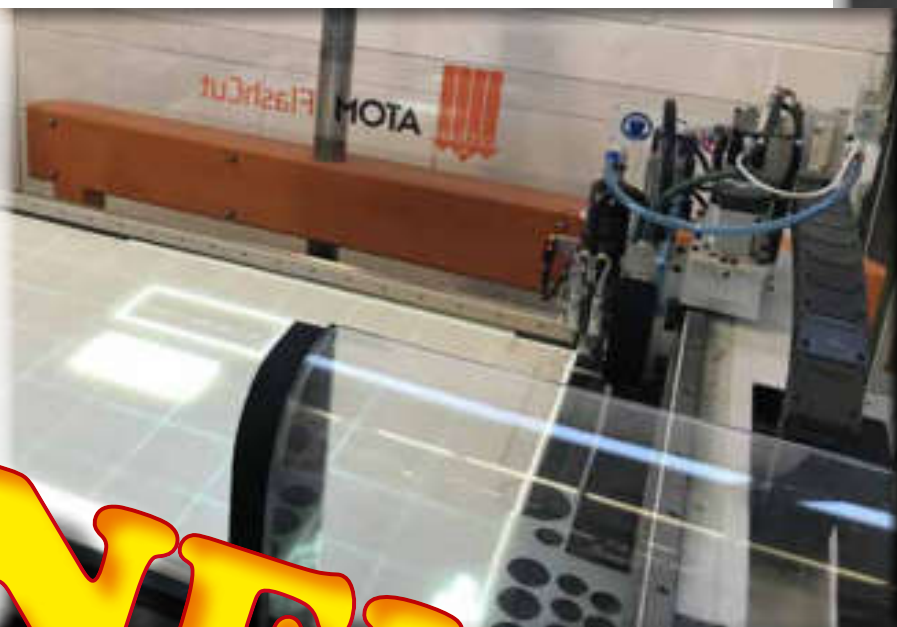

NEW!



Anelli, frammenti e rondelle. Realizzabili in Silicone ed EPDM.



Rings, tube fragments and washers. Silicone and EPDM made.

TMF
TMF

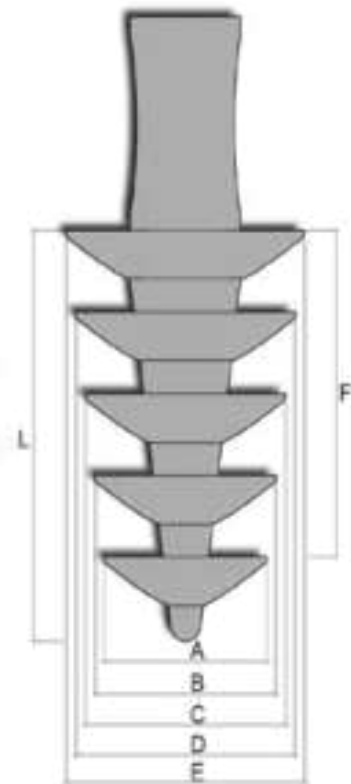

CODICE CODE	A	B	C	D	E	F	L	PZ CONF. PCS. BOX	€ / 1 CONF € / 1 BOX	€ / 5 CONF € / 5 BOX
TMF4-10	4,00	6,00	8,00	10,00	-	10,63	13,60	500	88,85	71,08
TMF8-16	8,00	10,00	12,00	14,00	16,00	19,00	23,50	200	93,22	74,58
TMF10-18	10,00	12,00	14,00	16,00	18,00	19,00	24,00	200	141,19	112,95



Anelli, frammenti e rondelle. Realizzabili in Silicone ed EPDM.



Rings, tube fragments and washers. Silicone and EPDM made.

Plus

AFR
AFR

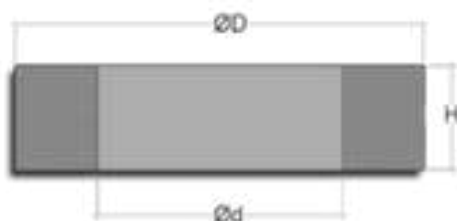

Altri materiali disponibili
Other materials available



Altre dimensioni realizzabili a richiesta senza costi aggiuntivi
Other sizes on demand with no additional cost

CODICE CODE	ØD	Ød	H (ALTEZZA) H (HEIGHT)	PZ CONF. PCS. BOX	€/CONF €/BOX
AFR8X3	8,00	3,00	1,50	100	12,94
AFR9X86	9,53	6,35	31,75	100	19,19
AFR13X8	13,00	8,00	2,00	100	7,77
AFR14X4	14,27	4,75	25,40	100	47,75
AFR16X9	16,00	9,50	2,00	100	9,65
AFR16X8	16,50	8,00	2,00	100	10,66
AFR21X8	21,20	8,00	10,00	10	6,44
AFR24X9	24,00	9,00	25,00	10	14,38
AFR24X12	24,00	12,00	3,00	10	1,65
AFR30X9	30,00	9,00	25,00	10	25,07
AFR32X26	32,00	26,00	160,00	10	83,58
AFR36X25	36,00	25,00	50,00	10	33,54
AFR39X32	39,00	32,00	2,00	10	1,71
AFR42X36	42,00	36,00	160,00	10	97,69
AFR47X41	47,00	41,00	160,00	10	108,23
AFR50X30	50,00	30,00	5,00	1	1,14
AFR52X46	52,00	46,00	160,00	1	11,88
AFR60X40	60,00	40,00	5,00	1	1,32
AFR60X50	60,20	50,00	80,00	1	10,24
AFR62X56	62,00	56,00	160,00	1	15,46
AFR65X32	65,00	32,00	2,00	1	0,87
AFR72X66	72,00	66,00	110,00	1	12,53
AFR78X12	78,80	12,50	10,00	1	6,57
AFR90X80	90,00	80,00	50,00	1	13,70
AFR100X85	100,00	85,00	20,00	1	10,49
AFR117X111	117,00	111,00	160,00	1	25,58
AFR164X146	164,00	146,00	5,00	1	7,00

 Tappo speciale per protezione dadi 315 °C

 Special nut protection plug 315 °C

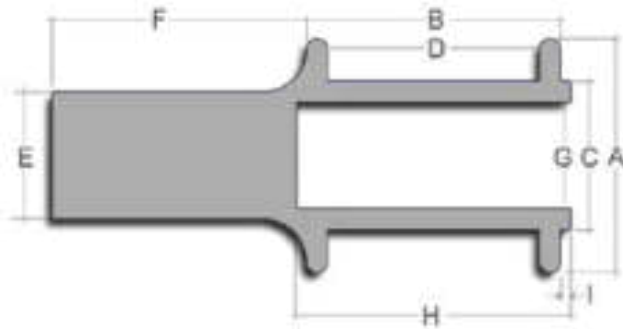

DFPP
DFPP



CODICE CODE	A	B	C	D	E	F	G	H	I	PZ CONF PCS. BOX	€/CONF. €/BOX
DFPP05	5,40	5,50	4,10	3,00	3,50	15,34	1,02	6,28	1,57	500	22,50
DFPP06	6,70	7,10	5,10	3,80	4,50	20,42	1,85	9,13	2,03	500	36,75
DFPP08	8,70	7,80	6,70	5,35	5,59	20,52	3,28	9,83	2,03	500	74,95
DFPP10	11,20	9,50	8,50	6,60	5,50	20,42	5,08	10,33	2,03	500	83,20
DFPP12	13,00	10,10	10,10	6,60	5,61	27,81	5,08	12,13	2,03	250	68,25
DFPP14	15,20	11,50	12,10	8,00	8,00	29,00	6,50	12,53	2,03	250	110,20
DFPP16	16,60	13,50	13,90	9,30	10,15	32,00	7,70	15,53	2,03	100	73,75
DFPP18	19,80	14,50	15,90	10,50	10,15	32,00	10,30	16,53	2,03	100	80,40
DFPP20	21,01	15,30	17,80	12,30	12,30	33,80	10,25	17,33	2,03	100	116,50

FORME E DIMENSIONI PERSONALIZZATE REALIZZABILI SU RICHIESTA



Tappi speciali con flangia 315 °C.

Indicati per rivestimenti in polvere, elettrostatici per immersione liquida e platinatura.



Countersink Plugs 315 °C.

Recommended for powder coating, E-coating and plating.

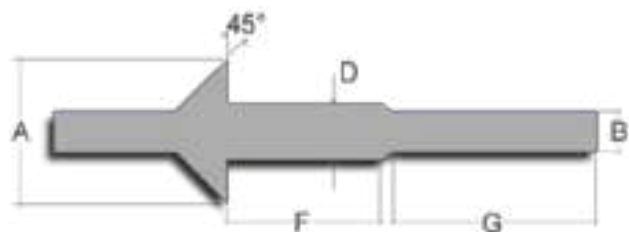

CSINK



CODICE CODE	A	B	D	F	G	PZ. CONF. PCS. BOX	€/CONF. €/BOX
CSINK030	10,00	2,50	2,90	15,00	20,00	100	26,00
CSINK040	10,00	3,00	3,80	15,00	20,00	100	27,56
CSINK045	12,00	3,00	4,50	15,00	20,00	100	28,70
CSINK050	15,00	4,00	5,00	15,00	20,00	100	29,68
CSINK060	14,00	4,00	5,50	15,00	20,00	100	32,16
CSINK080	16,00	4,00	7,40	15,00	20,00	100	51,12
CSINK100	18,00	5,00	9,20	15,00	25,00	100	62,76
CSINK120	20,00	5,00	11,00	15,00	25,00	100	65,89
CSINK140	20,00	6,00	13,46	15,00	20,00	100	67,90

FORME E DIMENSIONI PERSONALIZZATE REALIZZABILI SU RICHIESTA



Tappi con maniglia di estrazione 315 °C (CPP).

Per rivestimenti in polvere, elettrostatici per immersione liquida, anodizzazione e platinatura. Ideali per fori passanti.



Pull Plug 315 °C (CPP).

Recommended for powder coating, E-coating, anodizing and plating. Ideal for through holes.

CPP

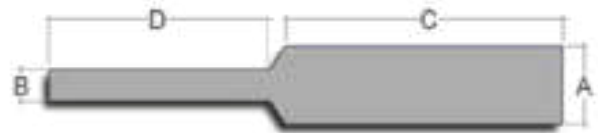

FORME E DIMENSIONI PERSONALIZZATE REALIZZABILI SU RICHIESTA

CODICE CODE	COLORE COLOR	FORI HOLES	A	B	C	D	PZ. CONF. PCS BOX	€/CONF. €/BOX
CPP06	blue		1,57	1,02	12,70	12,70	500	15,68
CPP07	white		1,70	1,19	15,88	15,49	500	16,68
CPP08	green		1,85	1,17	15,54	14,99	500	19,72
CPP09	red		2,31	1,32	15,88	15,88	500	20,20
CPP10(2)	pink		2,36	1,27	15,88	15,88	500	22,20
CPP95-1000	grey		2,41	1,32	25,40	25,40	500	28,90
CPP10(A)	light blue		2,67	2,08	25,40	25,40	500	24,80
CPP11	light green		2,77	1,57	25,40	25,40	500	26,00
CPP11B	yellow		3,00	2,08	25,40	25,40	500	35,85
CPP11A(3)	purple	3F	3,18	1,57	15,88	15,88	500	36,25
CPP15	blue	3L / 3F	3,30	2,36	15,88	17,78	500	37,05
CPP14	white	3L / 3F	3,30	2,36	25,40	25,40	500	32,15
CPP17	green	3L	3,56	2,16	15,88	14,17	500	31,95
CPP18	red		3,91	1,57	15,88	15,88	500	31,62
CPP20(4A)	pink	4F	3,96	1,57	15,88	19,05	500	34,12
CPP21	grey	4F	4,01	2,08	31,75	31,75	500	35,58
CPP22	light blue	4L / 4F	4,11	2,44	15,88	14,76	500	38,55
CPP23(4)	light green	5F	4,95	2,79	25,40	25,40	500	45,95
CPP26	purple	5F	5,00	2,79	25,40	25,40	500	52,15
CPP30	yellow	5L / 6F	5,54	3,30	25,40	25,40	500	66,25
CPP33	clear	5L / 6F	5,72	3,18	25,40	25,40	500	68,96
CPP37(5)	blue	6L	6,53	3,30	25,40	25,40	500	75,95
CPP40	white	6L / 8F	6,99	3,18	23,80	23,37	500	78,98
CPP42(6)	green	8F	7,92	3,73	25,40	25,40	500	85,56
CPP42	red	8L	8,43	6,35	28,58	20,29	500	99,56
CPP43	pink	8L	8,51	3,89	25,40	25,40	500	118,95
CPP355-1000	blue		9,02	3,99	25,40	25,40	500	150,04
CPP50	grey	10F	9,53	3,99	25,40	25,40	500	119,95
CPP55	light blue	10F	9,75	3,91	25,40	25,40	250	63,28
CPP55(7)	light green	10F	9,86	3,99	25,40	25,40	250	100,79
CPP60	yellow	10L / 12F	10,36	4,85	25,63	25,40	250	115,85
CPP63	purple	12F	10,52	3,99	13,34	19,18	250	116,10
CPP66	blue	12F	11,28	6,48	25,40	25,15	250	116,25
CPP67	white	12F	11,30	6,48	25,40	25,40	250	119,87
CPP70	white		11,89	6,35	25,40	25,40	250	121,47
CPP73	red	12L / 14F	12,60	6,35	25,40	25,40	250	122,37
CPP77	pink		12,95	6,50	25,40	24,28	250	125,88
CPP80	grey		13,46	6,35	25,40	25,40	250	135,40
CPP570-1000	light blue		14,48	7,92	25,40	25,40	100	82,94
CPP87	light green		15,54	6,35	25,40	25,40	100	87,43
CPP88	yellow		15,75	8,36	38,10	38,10	100	142,09
CPP90	purple		16,26	9,53	25,40	25,40	100	78,38
CPP95	green	16L	17,78	9,53	31,75	31,75	100	115,55
CPP100	blue		19,56	9,53	25,40	23,55	100	116,65
CPP809-1000	pink		20,55	8,00	25,40	25,40	50	76,91
CPP110(13)	white		22,76	9,53	25,40	25,40	50	55,85
CPP120	green		25,91	9,53	25,40	24,64	50	83,87
CPP130	red		35,05	12,70	25,40	25,40	50	234,94

L = liscio, smooth

F = filettato, threaded

Plus



Tappi con maniglia di estrazione E.P.D.M. 177 °C (EPP).

Indicati per verniciatura a liquido, platinatura, anodizzazione e sabbiatura. Ideali per fori passanti.



E.P.D.M. Pull Plug 177 °C (EPP).

Recommended for painting, plating, anodizing and blasting. Ideal for through holes.

EPP
EPP

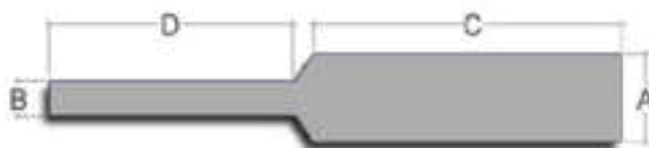

Altri materiali
disponibili
Other materials
available



FORME E DIMENSIONI PERSONALIZZATE REALIZZABILI SU RICHIESTA

CODICE CODE	FORI HOLES	A	B	C	D	PZ. CONF. PCS BOX	€/CONF. €/BOX
EPP06		1,57	1,02	12,70	12,70	500	14,66
EPP07		1,70	1,19	15,88	15,49	500	15,60
EPP08(1)		1,85	1,17	15,54	14,99	500	18,44
EPP09		2,31	1,32	15,88	15,88	500	18,89
EPP10(2)		2,36	1,27	15,88	15,88	500	20,76
EPP10A		2,67	2,08	25,40	25,40	500	23,19
EPP11		2,77	1,57	25,40	25,40	500	24,31
EPP11B		3,00	2,08	25,40	25,40	500	33,52
EPP11A(3)	3F	3,18	1,57	15,88	15,88	500	33,89
EPP15	3L / 3F	3,30	2,36	15,88	17,78	500	30,06
EPP14	3L / 3F	3,30	2,36	25,40	25,40	500	34,64
EPP17	3L	3,56	2,16	15,88	14,17	500	29,88
EPP18		3,91	1,57	15,88	15,88	500	29,57
EPP20(4A)	4F	3,96	1,57	15,88	19,05	500	31,90
EPP21	4F	4,01	2,08	31,75	31,75	500	36,07
EPP22	4L / 4F	4,11	2,44	15,88	14,76	500	36,05
EPP23(4)	5F	4,95	2,79	25,40	25,40	500	42,97
EPP26	5F	5,00	2,79	25,40	25,40	500	48,76
EPP30	5L / 6F	5,54	3,30	25,40	25,40	500	61,94
EPP33	5L / 6F	5,72	3,18	25,40	25,40	500	64,48
EPP37(5)	6L	6,53	3,30	25,40	25,40	500	71,02
EPP40	6L / 8F	6,99	3,18	23,80	23,37	500	73,84
EPP42(6)	8F	7,92	3,73	25,40	25,40	500	80,00
EPP42A	8L	8,43	6,35	28,58	20,29	500	93,09
EPP43	8L	8,51	3,89	25,40	25,40	500	148,62
EPP50		9,53	3,99	25,40	25,40	500	149,56
EPP55(7)	10F	9,86	3,99	25,40	25,40	250	59,17
EPP400-1000		10,16	3,99	25,40	25,40	250	82,53
EPP60	10L / 12F	10,36	4,85	25,63	25,40	250	108,32
EPP63		10,52	3,99	13,34	19,18	250	108,56
EPP66(8)	12F	11,28	6,48	25,40	25,15	250	108,69
EPP67(8)	12F	11,30	6,48	25,40	25,40	250	112,08
EPP70		11,89	6,35	25,40	25,40	250	113,58
EPP73(9)	12L / 14F	12,60	6,35	25,40	25,40	250	114,41
EPP77		12,95	6,50	25,40	24,28	250	117,70
EPP80(10)		13,46	6,35	25,40	25,40	250	126,60
EPP87		15,54	6,35	25,40	25,40	100	65,20
EPP88		15,75	8,36	38,10	38,10	100	105,86
EPP90(11)		16,26	9,53	25,40	25,40	100	73,28
EPP95	16L	17,78	9,53	31,75	31,75	100	108,04
EPP100(12)		19,56	9,53	25,40	23,55	100	109,07
EPP110(13)		22,76	9,53	25,40	25,40	50	52,22
EPP120(14)		25,91	9,53	25,40	24,64	50	78,41
EPP130		35,05	12,70	25,40	25,40	50	146,01

L = liscio, smooth

F = filettato, threaded

Tappi



Tappi 315 °C.

Indicato per rivestimenti in polvere, elettrostatici per immersione liquida e platinatura. Riutilizzabili.



Plugs 315 °C.

Recommended for powder coating, E-coating and plating. Reusable.

EP
EP

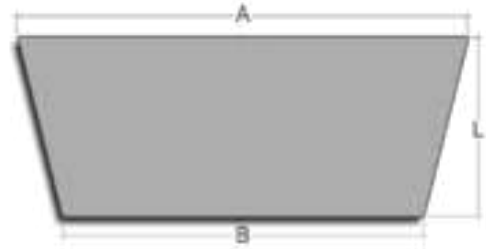

FORME E DIMENSIONI PERSONALIZZATE REALIZZABILI SU RICHIESTA

CODICE CODE	COLORE COLOR	FORI HOLES	A	B	LUNGH LENGTH	PZ CONF. PCS. BOX	€/CONF. €/BOX	€ 5 CONF (CAD.) € 5 BOXES (EACH)
EP63	light blue	1	1,60	0,41	15,88	1000	33,50	26,80
EP78	yellow	1	1,98	0,51	19,05	1000	37,50	30,00
EP81	clear	1-2	2,54	0,81	15,88	1000	41,85	33,48
EP99	white	1-3	3,18	0,79	15,88	1000	46,85	37,48
EP100	green	2-3	3,18	1,60	15,88	1000	47,30	37,84
EP101SH	purple	2-4	4,75	2,79	10,01	1000	46,45	37,16
EP101	pink	2-4	4,75	1,60	15,88	1000	49,59	39,67
EP101XL	light blue	2-4	4,75	1,60	19,05	1000	60,60	48,48
EP101SXL	yellow	2-4	4,75	1,60	25,40	1000	70,17	56,13
EP102	grey	4-6	6,35	3,18	19,05	1000	77,10	61,68
EP102XL	light green	4-6	6,35	3,18	25,40	1000	81,58	65,26
EP103	red	6-8	8,71	4,78	15,88	1000	101,45	81,16
EP103XL	pink	6-8	8,71	4,78	25,40	1000	129,15	103,32
EP105	green	7-9	9,53	6,35	12,70	100	20,28	16,22
EP104	yellow	7-9	9,53	6,35	19,05	100	17,88	14,30
EP375XL	light blue	5-8	9,53	3,18	31,75	100	55,30	44,24
EP394XL	light green	6-9	10,01	5,00	48,01	100	63,60	50,88
EP104XL	grey	7-9	11,10	6,35	25,40	100	22,82	18,26
EP106	red	9-10	11,13	8,74	17,48	100	28,03	22,42
EP000	white	9-10	11,91	8,74	20,65	100	24,66	19,73
EP000XL	green	9-11	12,70	7,90	25,40	100	30,95	24,76
EP500XL	pink	5-11	12,70	3,20	50,80	100	65,60	52,48
EP107	light blue	9-13	14,30	7,95	25,40	100	32,99	26,39
EP107XL	clear	4-13	15,01	3,00	35,00	100	58,30	46,64
EP00	grey	11-14	15,09	10,31	25,40	100	33,44	26,75
EP108	light green	12-14	15,88	11,13	22,23	100	50,80	40,64
EP0	red	14-16	16,66	12,70	25,40	100	47,73	38,18
EP109	clear	12-16	17,45	11,13	25,40	100	50,12	40,10
EP1	yellow	16-18	19,00	14,27	25,40	100	51,41	41,13
EP2	white	17-19	19,99	15,88	25,40	100	67,45	53,96
EP2,5	green	17-20	20,62	15,88	25,40	100	75,52	60,42
EP3	pink	19-22	23,83	18,26	25,40	100	83,58	66,86
EP3,5	clear	18-23	25,00	17,00	25,40	100	88,62	70,90
EP4	light blue	21-24	25,40	19,84	25,40	100	95,73	76,58
EP4,5	grey	22-25	26,01	19,99	25,40	100	102,19	81,75
EP5	light green	24-26	27,00	23,01	25,40	100	108,65	86,92
EP5,5	red	25-27	27,94	23,83	25,40	100	135,30	108,24
EP6	yellow	27-30	31,75	26,19	25,40	100	138,03	110,42
EP6,5	white	28-33	33,35	27,00	25,40	100	148,27	118,62
EP7	green	31-35	36,53	30,18	25,40	10	20,99	16,79
EP7,5	pink	32-38	38,89	31,75	25,40	10	22,99	18,39
EP8	light blue	34-40	41,28	33,35	25,40	10	23,25	18,60
EP8,5	grey	37-42	42,88	35,71	25,40	10	23,75	19,00
EP9	light green	38-43	44,45	37,31	25,40	10	24,25	19,40
EP9,5	red	39-45	46,05	38,10	25,40	10	35,99	28,79
EP10	yellow	42-49	50,01	41,28	25,40	10	36,99	29,59
EP10,5	white	45-52	52,40	44,45	25,40	10	39,99	31,99
EP11	green	49-55	55,96	47,63	25,40	1	4,79	3,83
EP11,5	pink	51-62	62,71	50,01	25,40	1	6,55	5,24
EP12	light blue	55-63	63,50	53,98	25,40	1	6,75	5,40
EP13	grey	58-67	68,28	57,94	25,40	1	8,69	6,95
EP13,5	light green	63-74	75,01	61,93	34,93	1	12,99	10,39
EP13,78	clear	72-80	82,00	68,00	35,00	1	13,99	11,19
EP14	red	77-88	88,90	76,20	38,10	1	14,99	11,99
EP15	yellow	83-100	101,60	82,55	38,10	1	26,40	21,12
EP16	white	90-126	127,00	88,90	50,80	1	43,06	34,45

Tappi



Tappi neri in E.P.D.M. 177 °C.

Indicati per verniciatura a liquido, platinatura, anodizzazione e sabbiatura.



Black E.P.D.M. Plugs 177 °C.

Recommended for painting, plating, anodizing and blasting.

BP
BP

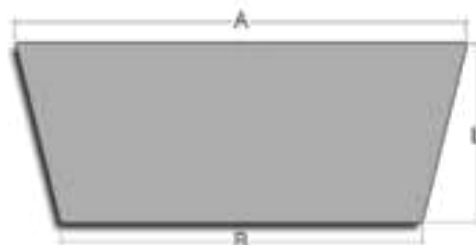

FORME E DIMENSIONI PERSONALIZZATE REALIZZABILI SU RICHIESTA

CODICE CODE	FORI HOLES	A	B	LUNGH LENGTH	PZ CONF. PCS. BOX	€/CONF. €/BOX	€ 5 CONF (CAD.) € 5 BOXES (EACH)
BP63	1	1,60	0,41	15,88	1000	24,12	19,30
BP78	1	1,98	0,51	19,05	1000	27,00	21,60
BP81	1-2	2,54	0,81	15,88	1000	30,13	24,10
BP99	1-3	3,18	0,79	15,88	1000	33,17	26,54
BP100	2-3	3,18	1,60	15,88	1000	35,86	28,69
BP101SH	2-4	4,75	2,79	10,01	1000	35,99	28,80
BP101	2-4	4,75	1,60	15,88	1000	37,24	29,79
BP101XL	2-4	4,75	1,60	19,05	1000	43,63	34,90
BP101SXL	2-4	4,75	1,60	25,40	1000	58,67	46,94
BP102	4-6	6,35	3,18	19,05	1000	41,97	33,58
BP102XL	4-6	6,35	3,18	25,40	1000	57,74	46,19
BP103	6-8	8,71	4,78	15,88	1000	52,65	42,12
BP103XL	6-8	8,71	4,78	25,40	1000	92,99	74,39
BP105	7-9	9,53	6,35	12,70	100	15,46	12,37
BP104	7-9	9,53	6,35	19,05	100	11,03	8,82
BP375XL	5-8	9,53	3,18	31,75	100	29,10	23,28
BP394XL	6-9	10,01	5,00	48,01	100	32,46	25,97
BP104XL	7-9	11,10	6,35	25,40	100	11,58	9,26
BP106	9-10	11,13	8,74	17,48	100	16,23	12,98
BP000	9-10	11,91	8,74	20,65	100	18,87	15,10
BP000XL	9-11	12,70	7,90	25,40	100	22,28	17,82
BP500XL	5-11	12,70	3,20	50,80	100	45,23	36,18
BP107	9-13	14,30	7,95	25,40	100	16,23	12,98
BP107XL	4-13	15,01	3,00	35,00	100	41,98	33,58
BP00	11-14	15,09	10,31	25,40	100	21,45	17,16
BP108	12-14	15,88	11,13	22,23	100	21,84	17,47
BP0	14-16	16,66	12,70	25,40	100	25,05	20,04
BP109	12-16	17,45	11,13	25,40	100	26,70	21,36
BP1	16-18	19,00	14,27	25,40	100	30,95	24,76
BP2	17-19	19,99	15,88	25,40	100	35,80	28,64
BP2,5	17-20	20,62	15,88	25,40	100	37,09	29,67
BP3	19-22	23,83	18,26	25,40	100	49,13	39,31
BP3,5	18-23	25,00	17,00	25,40	100	48,28	38,62
BP4	21-24	25,40	19,84	25,40	100	56,67	45,33
BP4,5	22-25	26,01	19,99	25,40	100	58,60	46,88
BP5	24-26	27,00	23,01	25,40	100	68,94	55,15
BP5,5	25-27	27,94	23,83	25,40	100	73,80	59,04
BP6	27-30	31,75	26,19	25,40	100	92,38	73,91
BP6,5	28-33	33,35	27,00	25,40	100	100,26	80,21
BP7	31-35	36,53	30,18	25,40	100	122,30	97,84
BP7,5	32-38	38,89	31,75	25,40	50	68,57	54,85
BP8	34-40	41,28	33,35	25,40	50	76,53	61,22
BP8,5	37-42	42,88	35,71	25,40	50	84,76	67,81
BP9	38-43	44,45	37,31	25,40	50	91,70	73,36
BP9,5	39-45	46,05	38,10	25,40	50	97,16	77,73
BP10	42-49	50,01	41,28	25,40	50	114,31	91,45
BP10,5	45-52	52,40	44,45	25,40	50	128,53	102,82
BP11	49-55	55,96	47,63	25,40	1	2,94	2,35
BP11,5	51-62	62,71	50,01	25,40	1	3,49	2,79
BP12	55-63	63,50	53,98	25,40	1	3,78	3,02
BP13	58-67	68,28	57,94	25,40	1	4,36	3,49
BP13,5	63-74	75,01	61,93	34,93	1	7,06	5,65
BP13,78	72-80	68,00	82,00	35,00	1	9,65	7,72
BP14	77-88	88,90	76,20	38,10	1	11,18	8,95
BP15	83-100	101,60	82,55	38,10	1	13,93	11,15
BP16	90-126	127,00	88,90	50,80	1	25,71	20,57



Tappi conici con maniglia 315 °C.

Indicato per rivestimenti in polvere, elettrostatici per immersione liquida e platinatura. Riutilizzabili.



Silicone conical plugs with handle 315 °C.

Recommended for powder coating, E-coating and plating. Reusable.

CPHS
CPHS

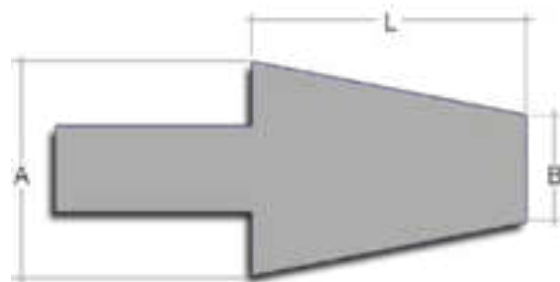

CODICE CODE	FORI HOLES	A	B	LUNGH LENGTH	PZ BOX PCS. BOX	€/CONF. €/BOX	€ 5 CONF (CAD.) € 5 BOXES (EACH)
CPHS100	1-3	3,18	1,60	15,88	1000	59,13	47,30
CPHS101	2-4	4,75	1,60	15,88	1000	61,99	49,59
CPHS102	4-6	6,35	3,18	19,05	1000	96,38	77,10
CPHS103	6-8	8,71	4,78	15,88	1000	126,81	101,45
CPHS104	7-9	9,53	6,35	19,05	100	22,35	17,88
CPHS000	9-10	11,91	8,74	20,65	100	30,83	24,66
CPHS00	11-14	15,09	10,31	25,40	100	41,80	33,44
CPHS0	14-16	16,66	12,70	25,40	100	59,66	47,73

FORME E DIMENSIONI PERSONALIZZATE REALIZZABILI SU RICHIESTA

IT Tappi copri-filetto 315 °C.

EM Thread mask 315 °C.

Plugs

ETM

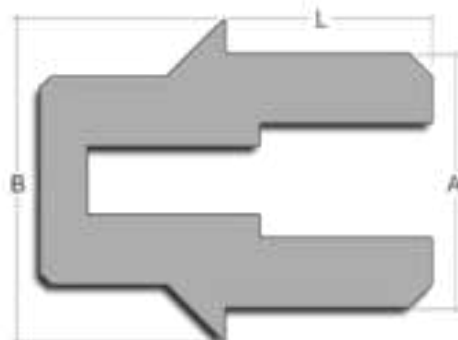

Altri materiali disponibili
Other materials available



CODICE CODE	COLORE COLOR	A	B	L	PZ CONF. PCS. BOX	€/CONF. €/BOX	€ 5 CONF (CAD.) € 5 BOX (EACH)
ETM6	green	5,33	6,35	5,08	500	31,50	25,20
ETM8	pink	7,20	8,55	3,20	500	42,00	33,60
ETM10	blue	9,00	10,15	4,70	250	33,60	26,88
ETM12	red	11,00	12,20	6,70	250	67,20	53,76
ETM16	yellow	14,90	16,60	8,30	100	42,00	33,60
ETM20	clear	18,40	20,50	10,30	100	58,80	47,04

FORME E DIMENSIONI PERSONALIZZATE REALIZZABILI SU RICHIESTA

 Tappo conico cavo con maniglia 315 °C.

 Hollow conical plug with handle 315 °C.

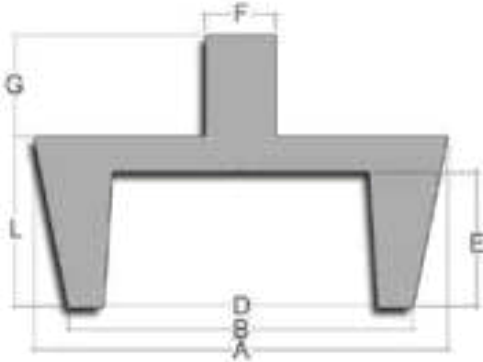

MHEP
MHEP



CODICE CODE	A	B	LUNGH. LENGTH	D	E	F	G	PZ CONF. PCS. BOX	€ 1 CONF € 1 BOX
MHEP5	27,00	23,01	25,40	10,31	19,05	10,21	19,05	100	191,23
MHEP6	31,75	26,19	25,40	13,49	19,05	12,70	19,05	100	242,93
MHEP7	36,50	30,15	25,40	17,45	19,05	12,70	19,05	10	36,94
MHEP10	50,01	41,28	25,40	28,58	19,05	12,70	19,05	10	65,10
MHEP11	55,96	47,63	25,40	34,93	19,05	12,70	19,05	1	8,43

FORME E DIMENSIONI PERSONALIZZATE REALIZZABILI SU RICHIESTA



Tappi con rondella 315 °C.

Ideale per mascherare attorno ad un foro per la messa a terra. Duplice possibilità d'uso.



Silicone Flange Plugs 315 °C.

Ideal for masking holes and the grounding area around them. Dual purpose plugs.

Plus

WFP

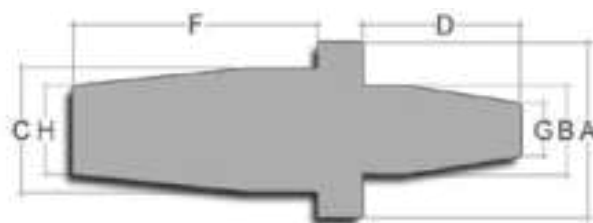

Altri materiali
disponibili
Other materials
available

CODICE CODE	FORO HOLE	A	B	C	D	F	G	H	PZ. CONF. PCS. BOX	€/CONF. €/BOX
WFP110-276-146	M3	7,00	2,80	3,70	5,80	7,40	1,40	1,90	1000	45,26
WFP142-354-195	M4	9,00	3,60	4,70	7,20	9,40	1,80	2,40	1000	55,11
WFP177-394-224	M5	9,50	4,50	5,70	9,00	11,40	2,30	2,80	1000	71,64
WFP289-492-264	M6	12,50	5,30	6,70	10,60	13,40	2,60	3,40	500	121,23
WFP280-669-343	M8	17,00	7,10	8,70	14,20	17,40	3,60	4,30	500	149,94
WFP378-827-421	M10	21,00	9,60	10,70	19,20	21,40	4,80	5,40	250	107,43
WFP429-945-500	M12	24,00	10,90	12,70	21,80	25,40	5,50	6,40	250	139,14

FORME E DIMENSIONI PERSONALIZZATE REALIZZABILI SU RICHIESTA



Tappi conici in silicone concavi 315 °C.

Indicato per rivestimenti in polvere, elettrostatici per immersione liquida e platinatura. Riutilizzabili.



Hollow silicone plugs 315 °C.

Recommended for powder coating, E-coating and plating. Reusable.

HEP
HEP

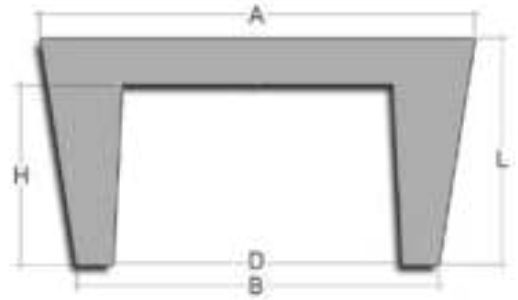

FORME E DIMENSIONI PERSONALIZZATE REALIZZABILI SU RICHIESTA

CODICE CODE	A	B	L	D	H	PZ CONF. PCS. BOX	€/CONF. €/BOX	€ 5 CONF (CAD.) € 5 BOX (EACH)
HEP5	27,00	23,01	25,40	12,50	19,05	100	119,52	95,62
HEP5,5	27,94	24,00	25,40	13,00	19,05	100	148,83	119,06
HEP6	32,00	26,19	25,40	15,50	19,05	100	151,83	121,46
HEP6,5	33,99	27,00	25,40	17,00	19,05	100	163,10	130,48
HEP7	36,53	30,18	25,40	17,48	19,05	10	23,09	18,47
HEP7,5	38,99	30,99	25,40	21,80	19,05	10	25,29	20,23
HEP8	41,28	33,35	25,40	20,65	19,05	10	25,58	20,46
HEP8,5	43,00	35,99	25,40	26,00	19,05	10	26,13	20,90
HEP9	44,45	37,31	25,40	24,61	19,05	10	26,68	21,34
HEP9,5	45,97	38,00	25,40	25,30	19,05	10	39,59	31,67
HEP10	49,99	41,99	25,40	31,60	19,05	10	40,69	32,55
HEP10,5	52,98	44,96	25,40	32,26	19,05	10	43,99	35,19
HEP11	55,96	48,01	25,40	35,31	19,05	1	5,27	4,22
HEP11,5	62,71	50,01	25,40	30,96	15,88	1	7,21	5,77
HEP12	63,50	53,98	25,40	34,93	15,88	1	7,43	5,94
HEP13	68,28	57,94	25,40	38,89	15,88	1	9,56	7,65
HEP13,5	75,01	61,93	34,93	42,88	25,40	1	14,29	11,43
HEP13,78	81,99	68,00	38,10	42,60	25,40	1	15,38	12,30
HEP14	88,90	76,20	38,10	50,80	25,40	1	16,49	13,19
HEP15	101,60	82,55	38,10	57,15	25,40	1	29,04	23,23
HEP16	127,00	88,90	50,80	78,00	30,00	1	47,37	37,90

Plus



Starter kit.



CODICE CODE	ARTICOLO ITEMS	PREZZO CAD. € PRICE EACH €
SKITSILI	Starter kit tappi e cappucci in silicone 315 °C	50,00
SKITEPDM	Starter kit tappi e cappucci in E.P.D.M 177 °C	45,00



Tappi senza flange 315 ° C.

Indicati per rivestimenti in polvere, elettrostatici per immersione liquida, platinatura e anodizzazione. Fori filettati. Forma conica e interno cavo per molteplici applicazioni. Proteggono i fori filettati senza mascherare la zona circostante.



Flangeless Plugs 315 °C.

Recommended for powder coating, E-coating, plating and anodizing. Threaded holes. Tapered design and hollow core for multi-applications. Protect threaded holes without masking the surrounding area.

FP
FP

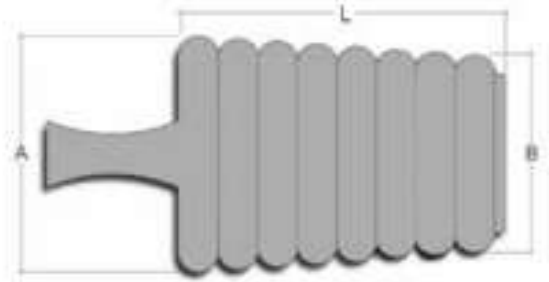

FORME E DIMENSIONI PERSONALIZZATE REALIZZABILI SU RICHIESTA

CODICE CODE	A	B	LUNGH. LENGTH	PZ. CONF. PCS. BOX	€/CONF. €/BOX	€ 5 CONF (CAD.) € 5 BOX (EACH)
FP157	3,99	2,01	19,05	250	53,12	42,50
FP250	5,99	3,99	25,40	250	67,87	54,30
FP312	8,00	5,99	25,40	250	88,23	70,58
FP394	10,01	8,00	25,40	250	89,90	71,92
FP406	10,31	7,95	25,40	250	90,50	72,40
FP468	11,89	10,31	25,40	250	101,84	81,47
FP472	11,99	10,01	25,40	250	108,64	86,91
FP551	14,00	11,99	25,40	250	111,35	89,08
FP562	14,27	11,89	25,40	250	113,13	90,50
FP625	15,88	14,27	25,40	250	124,57	99,66
FP630	16,00	14,00	25,40	250	128,98	103,18
FP709	18,01	16,00	25,40	250	132,65	106,12
FP718	18,24	15,88	25,40	250	135,74	108,59
FP750	19,05	18,24	25,40	100	58,88	47,10
FP787	19,99	18,01	25,40	100	65,90	52,72
FP866	22,23	19,05	25,40	100	68,04	54,43
FP886	22,50	19,99	25,40	100	72,34	57,87
FP945	24,00	22,50	25,40	100	77,99	62,39
FP1000	25,40	22,23	25,40	100	81,55	65,24
FP1024	26,01	24,00	25,40	100	89,25	71,40
FP1102	27,99	26,01	25,40	100	95,87	76,70
FP1125	28,58	25,40	25,40	100	99,90	79,92
FP1250	31,75	28,58	25,40	100	113,17	90,54

Plus

Altri materiali
disponibili
Other materials
available



Tappi a gradino 315 °C.

Indicati per rivestimenti in polvere, elettrostatici per immersione liquida, anodizzazione e platinatura. Assicura una zona pulita attorno al diametro del foro per la messa a terra.



Step Plugs 315 °C.

Recommended for powder coating, E-coating, anodizing and plating. Provides clean area around diameter of hole for earthing purpose.

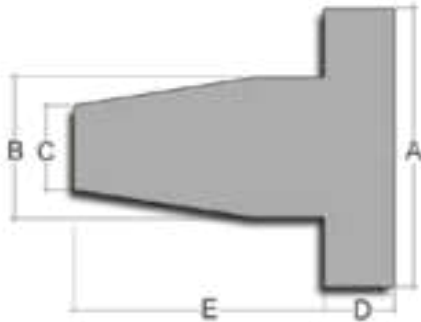

SP
SP



CODICE CODE	A	B	C	D	E	PZ. CONF. PCS. BOX	€/CONF. €/BOX	€ 5 CONF (CAD.) € 5 BOX (EACH)
SP03	7,01	3,00	2,36	7,01	13,00	500	69,95	55,96
SP04	8,00	5,00	2,84	8,00	14,00	500	75,44	60,35
SP05	8,99	5,99	3,94	8,99	16,03	500	94,31	75,45
SP06	10,16	6,43	4,78	10,16	17,63	250	61,36	49,09
SP08	12,42	8,23	5,94	9,75	17,32	250	77,26	61,81

FORME E DIMENSIONI PERSONALIZZATE REALIZZABILI SU RICHIESTA

 **Rivestimenti in polvere Cappucci 315 °C.**

 **Powder Coating Caps 315 °C.**



Caps

EC^{EC}



Altri materiali disponibili
Other materials available



CODICE CODE	COLOR	FILETTO THREAD	A	C	LUNGH LENGTH	PZ CONF. PCS. BOX	€/CONF €/BOX	€ 5 CONF (CAD.) € 5 BOXES (EACH)
EC20	clear		0,51	3,55	12,70	1000	25,45	20,36
EC35	purple		0,89	3,43	12,70	1000	28,79	23,03
EC40-500	clear		1,02	3,32	12,70	1000	26,24	20,99
EC40-750	clear		1,02	3,30	19,05	1000	32,90	26,32
EC62-750	orange		1,57	3,80	19,05	1000	50,61	40,49
EC70	rusty red	M2	1,78	4,08	25,40	1000	58,17	46,54
EC80-750	grey		2,03	5,07	19,05	1000	61,01	48,81
EC93-500	white		2,36	4,95	12,70	1000	58,95	47,16
EC93-750	white		2,36	4,95	19,05	1000	62,10	49,68
EC100-500	green	M3	2,54	5,13	12,70	1000	59,95	47,96
EC100-750	green	M3	2,54	5,13	19,05	1000	64,54	51,63
EC100	green	M3	2,54	5,13	25,40	1000	73,09	58,47
EC100-1500	green	M3	2,54	5,58	38,10	1000	125,36	100,29

FORME E DIMENSIONI PERSONALIZZATE REALIZZABILI SU RICHIESTA

CODICE CODE	COLORE COLOR	FILETTO THREAD	A	C	LUNGH LENGTH	PZ CONF. PCS. BOX	€/CONF €/BOX	€ 5 CONF (CAD.) € 5 BOXES (EACH)
EC109-500	red		2,77	5,81	12,70	1000	60,00	48,00
EC109	red		2,77	5,36	19,05	1000	65,09	52,07
EC125-500	blue		3,18	5,77	12,70	1000	61,01	48,81
EC125-750	blue		3,18	6,22	19,05	1000	69,98	55,99
EC125	blue		3,18	5,77	25,40	1000	78,09	62,47
EC125-1500	blue		3,18	6,22	38,10	1000	130,80	104,64
EC137-1000	green		3,48	6,52	25,40	1000	83,56	66,85
EC140-500	white		3,56	6,60	12,70	1000	73,13	58,50
EC140	white		3,56	6,60	25,40	1000	85,28	68,22
EC148-500	grey	M4	3,76	6,80	12,70	1000	75,78	60,62
EC148-750	grey	M4	3,76	6,80	19,05	1000	85,19	68,15
EC148	grey	M4	3,76	6,80	25,40	1000	97,61	78,09
EC148-1500	grey	M4	3,76	6,80	38,10	1000	137,74	110,20
EC156-500	yellow		3,96	7,00	12,70	1000	78,70	62,96
EC156	yellow		3,96	7,00	25,40	1000	100,37	80,30
EC165-1000	clear		4,19	7,23	25,40	1000	105,39	84,31
EC172-500	blue		4,37	7,41	12,70	1000	83,68	66,94
EC172	blue		4,37	7,41	25,40	1000	110,00	88,00
EC172-1500	blue		4,37	7,41	38,10	1000	123,57	98,86
EC180	grey		4,57	7,61	25,40	1000	113,89	91,11
EC187-500	red	M5	4,75	7,79	12,70	1000	105,91	84,73
EC187-750	red	M5	4,75	7,79	19,05	1000	113,48	90,78
EC187	red	M5	4,75	7,79	25,40	1000	115,91	92,73
EC187-1500	red	M5	4,75	7,79	38,10	1000	129,90	103,92
EC197-500	clear		5,00	8,04	12,70	500	66,80	53,44
EC218	light blue		5,54	8,58	25,40	500	64,14	51,31
EC223-500	pink	M6	5,66	8,70	12,70	500	52,40	41,92
EC223-750	pink	M6	5,66	8,70	19,05	500	56,88	45,50
EC223-1000	pink	M6	5,66	8,70	25,40	500	59,95	47,96
EC223	pink	M6	5,66	8,70	38,10	500	66,94	53,55
EC234-500	green		5,94	8,98	12,70	500	58,76	47,01
EC234-750	green		5,94	8,98	20,00	500	63,56	50,85
EC234	green		5,94	8,98	25,40	500	68,76	55,01
EC234-1500	green		5,94	8,98	38,10	500	80,76	64,61
EC250-500	grey		6,35	9,39	12,70	500	48,48	38,78
EC250	grey		6,35	9,39	25,40	500	69,23	55,38
EC260	red		6,60	9,64	25,40	500	73,23	58,58
EC281	light green		7,14	10,18	25,40	500	74,27	59,42
EC281-2000	light green		7,14	10,18	50,80	500	133,61	106,89
EC295-500	light blue	M8	7,49	10,53	12,70	500	75,88	60,70
EC295-750	light blue	M8	7,49	10,53	19,05	500	79,90	63,92
EC295-1000	light blue	M8	7,49	10,53	25,40	500	83,92	67,14
EC295	light blue	M8	7,49	10,53	38,10	500	77,88	62,30
EC295-2350	light blue	M8	7,49	10,53	59,00	500	124,61	99,69
EC312	white		7,92	10,96	25,40	500	85,85	68,68
EC312-1500	white		7,92	10,96	38,10	500	120,70	96,56
EC340	grey		8,64	11,68	25,40	500	95,95	76,76
EC355	purple		9,02	12,06	38,10	500	115,04	92,03
EC375-750	yellow	M10	9,53	12,57	19,05	500	80,20	64,16
EC375	yellow	M10	9,53	12,57	25,40	500	90,38	72,31
EC375-1500	yellow	M10	9,53	12,57	38,10	500	123,91	99,13
EC375-1969	yellow	M10	9,53	12,57	50,01	500	156,72	125,38
EC406	red		10,31	13,35	25,40	500	100,52	80,42
EC406-1500	red		10,31	13,35	38,10	500	139,68	111,75
EC437	green		11,10	14,14	25,40	500	118,89	95,11

CODICE CODE	COLOR	FILETTO THREAD	A	C	LUNGH LENGTH	PZ CONF. PCS. BOX	€/CONF €/BOX	€ 5 CONF (CAD.) € 5 BOXES (EACH)
EC437-2000	green		11,10	14,14	50,80	500	210,63	168,50
EC456-500	pink	M12	11,58	14,62	12,70	500	73,20	58,56
EC456-750	pink	M12	11,58	14,62	19,05	500	95,57	76,45
EC456-1000	pink	M12	11,58	14,62	25,40	500	118,32	94,66
EC456	pink	M12	11,58	14,62	38,10	500	125,91	100,73
EC456-1969	pink	M12	11,58	14,62	50,01	500	205,87	164,70
EC468	orange		11,89	14,93	25,40	500	121,47	97,18
EC468-1500	orange		11,89	14,93	38,10	500	163,98	131,18
EC480-1000	grey		12,19	15,23	25,40	500	113,33	90,67
EC480	grey		12,19	15,23	38,10	500	134,23	107,39
EC500-750	light blue		12,70	15,74	19,05	500	96,08	76,86
EC500	light blue		12,70	15,74	38,10	500	137,84	110,27
EC535-750	yellow		13,59	16,63	19,05	250	64,57	51,65
EC535	yellow		13,59	16,63	38,10	250	79,87	63,90
EC535-3000	yellow		13,59	16,63	76,20	250	183,67	146,94
EC562-659	blue		14,27	17,31	16,74	250	54,19	43,36
EC562	blue		14,27	17,31	38,10	250	81,95	65,56
EC600	clear	M16	15,24	18,28	38,10	250	83,00	66,40
EC625-750	red		15,88	18,92	19,05	250	85,52	68,42
EC625-1125	red		15,88	18,92	28,58	250	82,13	65,71
EC625-1250	red		15,88	18,92	31,75	250	88,95	71,16
EC625	red		15,88	18,92	38,10	250	92,76	74,21
EC625-2500	red		15,88	18,92	63,50	250	180,37	144,30
EC687	green		17,45	20,49	38,10	250	96,70	77,36
EC687-2500	green		17,45	20,49	63,50	250	157,15	125,72
EC730	purple		18,54	21,58	38,10	250	100,04	80,03
EC750	orange		19,05	22,09	38,10	250	102,52	82,02
EC750-2000	orange		19,05	22,09	50,80	250	187,38	149,90
EC750-3500	orange		19,05	22,09	88,90	250	221,89	177,51
EC780	clear		19,81	22,85	38,10	250	104,94	83,95
EC812	clear		20,62	23,66	38,10	250	109,80	87,84
EC845-2844	clear		21,46	24,50	72,24	250	239,56	191,64
EC875-1000	clear		22,23	25,27	25,40	250	101,13	80,91
EC875	clear		22,23	25,27	38,10	250	119,56	95,65
EC937	clear		23,80	26,84	38,10	250	150,75	120,60
EC970	clear		24,64	27,68	38,10	250	153,75	123,00
EC1000	clear		25,40	28,44	38,10	250	156,18	124,94
EC1000-2000	clear		25,40	28,44	50,80	250	222,41	177,93
EC1062	clear		26,97	30,01	38,10	100	73,23	58,58
EC1062-2000	clear		26,97	30,01	50,80	100	92,36	73,89
EC1125	clear		28,58	31,62	38,10	100	75,66	60,53
EC1187	clear		30,15	33,19	38,10	100	80,52	64,42
EC1250	clear		31,75	34,79	38,10	100	90,28	72,22
EC1350	clear		34,29	37,33	38,10	100	95,18	76,14
EC1380	clear		35,05	38,09	38,10	100	98,13	78,50
EC1500	clear		38,10	41,14	25,40	100	100,00	80,00
EC1500-1500	clear		38,10	41,14	38,10	100	108,65	86,92
EC1500-1750	clear		38,10	41,14	44,45	50	58,44	46,75
EC1625	clear		41,28	44,32	50,80	50	125,57	100,46
EC1750	clear		44,45	47,49	50,80	50	156,18	124,94
EC1875	clear		47,63	50,67	50,80	50	165,84	132,67
EC2000	clear		50,80	53,84	50,80	50	195,22	156,18
EC2105	clear		53,47	56,51	50,80	50	216,69	173,35

Cappucci



Cappucci in E.P.D.M. 177 °C.

Indicati per verniciatura a liquido, platinatura, anodizzazione. Riutilizzabili.



E.P.D.M. Caps 177 °C.

Recommended for painting, plating and anodizing. Reusable.

EE
EE



CODICE CODE	FILETTO THREAD	A	C	LUNGH LENGTH	PZ BOX PCS. BOX	€/CONF. €/BOX	€ 10 CONF (CAD.) € 10 BOXES (EACH)
EE20-500		0,51	3,55	12,70	1000	18,83	15,06
EE35-500		0,89	3,43	12,70	1000	19,35	15,48
EE40-500		1,02	3,32	12,70	1000	18,16	14,53
EE40-750		1,02	3,30	19,05	1000	22,48	17,98
EE62-750		1,57	4,61	19,05	1000	27,83	22,26
EE70-1000	M2	1,78	4,08	25,40	1000	28,07	22,46
EE80-750		2,03	5,07	19,05	1000	32,89	26,31
EE93-500		2,36	4,95	12,70	1000	28,44	22,75
EE93-750		2,36	4,95	19,05	1000	29,04	23,23
EE93-1000	M3	2,36	5,40	25,40	1000	34,24	27,39
EE100-500	M3	2,54	5,13	12,70	1000	29,12	23,30
EE100-1000	M3	2,54	5,13	25,40	1000	29,34	23,47
EE100-1500	M3	2,54	5,58	38,10	1000	49,98	39,98

FORME E DIMENSIONI PERSONALIZZATE REALIZZABILI SU RICHIESTA

CODICE CODE	FILETTO THREAD	A	C	LUNGH LENGTH	PZ CONF. PCS. BOX	€/CONF. €/BOX	€ 10 CONF (CAD.) € 10 BOXES (EACH)
EE109-500		2,77	5,81	12,70	1000	29,04	23,23
EE109-750		2,77	5,36	19,05	1000	31,35	25,08
EE125-500		3,18	5,77	12,70	1000	29,04	23,23
EE125-750		3,18	6,22	19,05	1000	31,01	24,81
EE125-1000		3,18	5,77	25,40	1000	32,67	26,14
EE125-1500		3,18	6,22	38,10	1000	55,69	44,55
EE137-1000		3,48	6,52	25,40	1000	43,67	34,94
EE140-500		3,56	6,60	12,70	1000	29,04	23,23
EE140-1000		3,56	6,60	25,40	1000	36,09	28,87
EE148-500	M4	3,76	6,80	12,70	1000	29,35	23,48
EE148-750	M4	3,76	6,80	19,05	1000	31,69	25,35
EE148-1000	M4	3,76	6,80	25,40	1000	37,49	29,99
EE148-1500	M4	3,76	6,80	38,10	1000	52,82	42,25
EE156-500		3,96	7,00	12,70	1000	32,67	26,14
EE156-1000		3,96	7,00	25,40	1000	38,90	31,12
EE165-1000		4,19	7,23	25,40	1000	45,41	36,33
EE172-500		4,37	7,41	12,70	1000	32,67	26,14
EE172-1000		4,37	7,41	25,40	1000	41,72	33,38
EE172-1500		4,37	7,41	38,10	1000	65,66	52,53
EE180-1000		4,57	7,61	25,40	1000	48,07	38,46
EE187-500	M5	4,75	7,79	12,70	1000	34,76	27,81
EE187-750	M5	4,75	7,79	19,05	1000	46,06	36,85
EE187-1000	M5	4,75	7,79	25,40	1000	44,48	35,58
EE187-1500	M5	4,75	7,79	38,10	1000	69,72	55,78
EE197-500		5,00	8,04	12,70	500	15,40	12,32
EE218-1000		5,54	8,58	25,40	500	27,93	22,34
EE223-500	M6	5,66	8,70	12,70	500	17,55	14,04
EE223-750	M6	5,66	8,70	19,05	500	26,58	21,27
EE223-1000	M6	5,66	8,70	25,40	500	25,65	20,52
EE223-1500	M6	5,66	8,70	38,10	500	39,97	31,98
EE234-500		5,94	8,98	12,70	500	17,73	14,19
EE234-787		5,94	8,98	19,99	500	24,67	19,73
EE234-1000		5,94	8,98	25,40	500	26,69	21,35
EE234-1500		5,94	8,98	38,10	500	48,48	38,78
EE250-500		6,35	9,39	12,70	500	21,98	17,58
EE250-1000		6,35	9,39	25,40	500	28,15	22,52
EE260-1000		6,60	9,64	25,40	500	32,48	25,99
EE281-1000		7,14	10,18	25,40	500	31,22	24,98
EE281-2000		7,14	10,18	50,80	500	72,65	58,12
EE295-500	M8	7,49	10,53	12,70	500	25,57	20,46
EE295-750	M8	7,49	10,53	19,05	500	33,87	27,09
EE295-1000	M8	7,49	10,53	25,40	500	32,43	25,94
EE295-1500	M8	7,49	10,53	38,10	500	58,98	47,18
EE295-2350	M8	7,49	10,53	60,00	500	87,73	70,18
EE312-1000		7,92	10,96	25,40	500	34,15	27,32
EE312-1500		7,92	10,96	38,10	500	62,07	49,66
EE340-1000		8,64	11,68	25,40	500	36,96	29,57
EE355-1500		9,02	12,06	38,10	500	69,79	55,84
EE375-750	M10	9,53	12,57	19,05	500	42,52	34,02
EE375-1000	M10	9,53	12,57	25,40	500	40,70	32,56
EE375-1500	M10	9,53	12,57	38,10	500	73,44	58,75
EE375-1969	M10	9,53	12,57	50,01	500	92,65	74,12
EE406-1000		10,31	13,35	25,40	500	43,91	35,13
EE406-1500		10,31	13,35	38,10	500	79,03	63,22
EE437-1000		11,10	14,14	25,40	500	47,33	37,87
EE437-2000		11,10	14,14	50,80	500	92,99	74,39

CODICE CODE	FILETTO THREAD	A	C	LUNGH LENGTH	PZ CONF. PCS. BOX	€/CONF. €/BOX	€ 10 CONF (CAD.) € 10 BOXES (EACH)
EE456-500	M12	11,58	14,62	12,70	500	34,07	27,26
EE456-750	M12	11,58	14,62	19,05	500	44,57	35,66
EE456-1000	M12	11,58	14,62	25,40	500	49,25	39,40
EE456-1500	M12	11,58	14,62	38,10	500	75,87	60,70
EE456-1969	M12	11,58	14,62	50,01	500	95,44	76,35
EE468-1000		11,89	14,93	25,40	500	56,40	45,12
EE468-1500		11,89	14,93	38,10	500	77,83	62,27
EE480-1000		12,19	15,23	25,40	500	57,92	46,34
EE480-1500		12,19	15,23	38,10	500	79,80	63,84
EE500-750		12,70	15,74	19,05	500	49,02	39,21
EE500-1500		12,70	15,74	38,10	500	74,68	59,75
EE535-750		13,59	16,63	19,05	250	26,43	21,14
EE535-1500		13,59	16,63	38,10	250	39,98	31,98
EE535-3000		13,59	16,63	76,20	250	80,69	64,55
EE562-659		14,27	17,31	16,74	250	25,63	20,51
EE562-1500		14,27	17,31	38,10	250	42,07	33,65
EE600-1500	M16	15,24	18,28	38,10	250	45,03	36,03
EE625-1125		15,88	18,92	28,58	250	41,88	33,50
EE625-1250		15,88	18,92	31,75	250	45,37	36,30
EE625-1500		15,88	18,92	38,10	250	46,99	37,59
EE625-2500		15,88	18,92	63,50	250	80,10	64,08
EE687-1500		17,45	20,49	38,10	250	51,94	41,55
EE687-2500		17,45	20,49	63,50	250	88,14	70,51
EE730-1500		18,54	21,58	38,10	250	61,90	49,52
EE750-1500		19,05	22,09	38,10	250	57,18	45,74
EE750-2000		19,05	22,09	50,80	250	80,12	64,09
EE750-3500		19,05	22,09	88,90	250	129,44	103,55
EE780-1500		19,81	22,85	38,10	250	66,59	53,27
EE812-1500		20,62	23,66	38,10	250	62,44	49,95
EE845-2844		21,46	24,50	72,24	250	122,08	97,67
EE875-1000		22,23	25,27	25,40	250	56,83	45,46
EE875-1500		22,23	25,27	38,10	250	68,00	54,40
EE937-1500		23,80	26,84	38,10	250	73,50	58,80
EE970-1500		24,64	27,68	38,10	250	85,34	68,27
EE1000-1500		25,40	28,44	38,10	250	88,45	70,76
EE1000-2000		25,40	28,44	50,80	250	109,92	87,94
EE1062-1500		26,97	30,01	38,10	100	34,07	27,26
EE1062-2000		26,97	30,01	50,80	100	47,05	37,64
EE1125-1500		28,58	31,62	38,10	100	36,52	29,21
EE1187-1500		30,15	33,19	38,10	100	49,85	39,88
EE1250-1500		31,75	34,79	38,10	100	51,55	41,24
EE1350-1500		34,29	37,33	38,10	100	59,35	47,48
EE1380-1500		35,05	38,09	38,10	100	52,93	42,35
EE1500-1000		38,10	41,14	25,40	100	53,06	42,45
EE1500-1500		38,10	41,14	38,10	100	55,90	44,72
EE1500-1750		38,10	41,14	44,45	100	75,20	60,16
EE1625-2000		41,28	44,32	50,80	50	35,05	28,04
EE1750-2000		44,45	47,49	50,80	50	38,47	30,78
EE1875-2000		47,63	50,67	50,80	50	54,58	43,67
EE2000-2000		50,80	53,84	50,80	50	45,98	36,78
EE2105-2000		53,47	56,51	50,80	50	63,41	50,73

 Cappucci copri-faston 315 °C.

 Square silicone caps 315 °C.

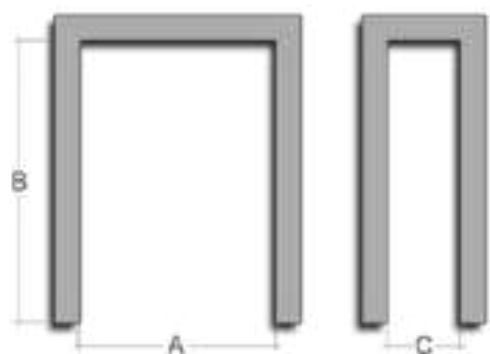

EQ^{EQ}

Caps

Altri materiali
disponibili
Other materials
available

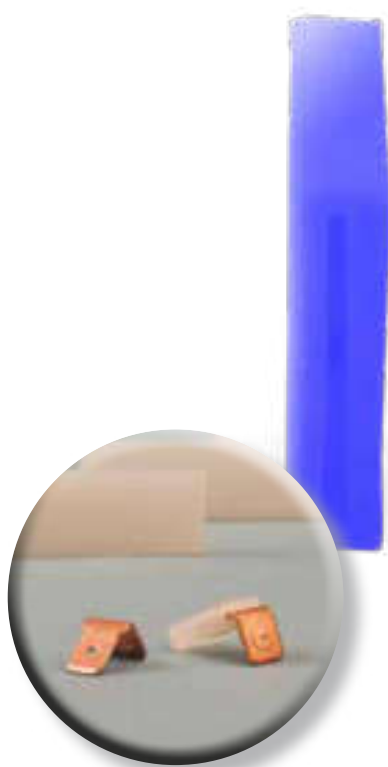

CODICE CODE	A	B	C	PZ. CONF. PCS. BOX	€/CONF. €/BOX
EQ157	3,99	19,99	0,61	1000	114,78
EQ232	5,89	11,00	0,79	1000	117,09
EQ250	6,35	10,92	0,79	1000	118,15
EQ460	11,68	7,11	0,89	500	121,90
EQ470	11,94	9,50	1,02	500	124,70
EQ490	12,45	17,45	1,19	500	129,95

FORME E DIMENSIONI PERSONALIZZATE REALIZZABILI SU RICHIESTA

Cappucci

 Cappucci a testa piatta 315 °C.

 Flat caps 315 °C.

FC^{FC}
FC

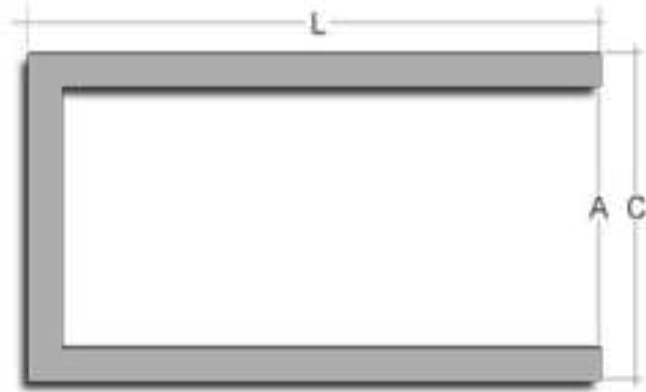

Altri materiali
disponibili
Other materials
available



FORME E DIMENSIONI PERSONALIZZATE REALIZZABILI SU RICHIESTA

CODICE CODE	A	C	LUNGH. LENGTH	PZ CONF. PCS. BOX	€/CONF. €/BOX	€ 5 CONF (CAD.) € 5 BOX (EACH)
FC70-1000	1,78	4,82	25,40	1000	57,41	45,93
FC100-1000	2,54	5,58	25,40	1000	68,59	54,88
FC100-1120	2,54	5,58	28,45	1000	74,92	59,94
FC120-400	3,05	6,09	10,16	1000	39,12	31,29
FC120-1000	3,05	6,09	25,40	1000	76,09	60,87
FC145-1120	3,68	6,72	28,45	1000	94,40	75,52
FC148-1000	3,76	6,80	25,40	1000	87,06	69,65
FC172-800	4,37	7,41	20,32	1000	80,02	64,02
FC175-1000	4,45	7,49	25,40	1000	97,20	77,76
FC185-1120	4,70	7,74	28,45	1000	111,67	89,33
FC220-1120	5,59	8,63	28,45	500	63,34	50,67
FC220-1650	5,59	8,63	41,91	500	88,66	70,93
FC223-1500	5,66	8,70	38,10	500	82,43	65,94
FC234-1500	5,94	8,98	38,10	500	85,54	68,43
FC295-250	7,49	10,53	6,35	500	27,47	21,98
FC295-1500	7,49	10,53	38,10	500	103,33	82,66
FC300-1120	7,62	10,66	28,45	500	81,24	64,99
FC300-1650	7,62	10,66	41,91	500	113,90	91,12
FC355-1500	9,02	12,06	38,10	500	120,76	96,61
FC375-1120	9,53	12,57	28,45	500	98,52	78,81
FC375-1500	9,53	12,57	38,10	500	126,84	101,47
FC393-728	9,98	13,02	18,49	500	72,52	58,02
FC415-1500	10,54	13,58	38,10	500	139,05	111,24
FC437-1000	11,10	14,14	25,40	500	102,89	82,31
FC440-728	11,18	14,22	18,49	500	80,53	64,43
FC456-1120	11,58	14,62	28,45	500	117,67	94,14
FC456-1500	11,58	14,62	38,10	500	151,43	121,14
FC480-1500	12,19	15,23	38,10	500	158,81	127,05
FC535-1500	13,59	16,63	38,10	250	88,00	70,40
FC562-1500	14,27	17,31	38,10	250	92,10	73,68
FC590-708	14,99	18,03	17,98	250	52,58	42,07
FC600-1500	15,24	18,28	38,10	250	98,20	78,56
FC640-900	16,26	19,30	22,86	250	68,64	54,91
FC640-2000	16,26	19,30	50,80	250	134,56	107,64
FC665-732	16,89	19,93	18,59	250	60,95	48,76
FC687-330	17,45	20,49	8,38	250	37,47	29,98
FC722-4555	18,34	21,38	115,70	250	322,27	257,81
FC728-452	18,49	21,53	11,48	250	48,27	38,62
FC730-1500	18,54	21,58	38,10	250	119,19	95,35
FC730-4000	18,54	21,58	101,60	250	288,10	230,48
FC736-728	18,69	21,73	18,49	250	67,68	54,15
FC811-728	20,60	23,64	18,49	250	75,13	60,11
FC855-1500	21,72	24,76	38,10	250	140,13	112,11
FC921-728	23,39	26,43	18,49	250	86,57	69,26
FC970-4000	24,64	27,68	101,60	250	380,22	304,18
FC980-1500	24,89	27,93	38,10	250	161,71	129,37
FC-1000-650	25,40	28,44	16,51	250	88,10	70,48
FC-1291-905	32,79	35,83	22,99	100	59,85	47,88
FC-1555-1102	39,50	42,54	27,99	50	42,94	34,35
FC-1649-1102	41,88	44,92	27,99	50	46,09	36,87
FC-1772-670	45,01	48,05	17,02	50	36,78	29,43
FC-1850-1102	46,99	50,03	27,99	50	53,10	42,48
FC-1957-1515	49,71	52,75	38,48	50	71,22	56,98
FC-2885-1000	73,28	76,32	25,40	50	89,48	71,59

Cappucci



Cappucci ad uso facilitato 315 °C.

L'anello interno migliora la tenuta del cappuccio, mentre la rondella ne permette una facile estrazione.



Easy use caps 315 °C.

Internal ring improve cap tightness and the flange in the head allows an easy handling.

SZC
SZC

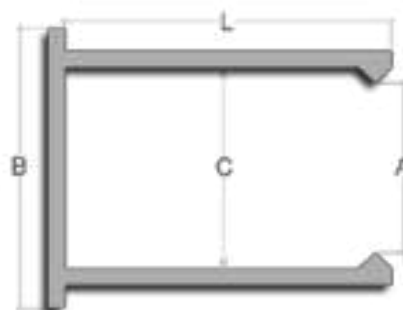

CODICE CODE	A	B	C	LUNGH. LENGTH	PZ CONF. PCS. BOX	€/CONF. €/BOX	€ 5 CONF (CAD.) € 5 BOX (EACH)
SZC125-2000	3,18	16,51	6,35	50,80	500	233,94	187,15
SZC135-1180	3,43	16,76	6,60	29,97	500	159,19	127,35
SZC138-1180	3,51	16,84	6,68	29,97	500	160,41	128,33
SZC156-2000	3,96	17,30	7,14	50,80	500	254,60	203,68
SZC157-1180	3,99	17,32	7,16	29,97	500	168,94	135,15
SZC165-1016	4,19	17,53	7,37	25,81	500	154,61	123,68
SZC177-1180	4,50	17,83	7,67	29,97	500	177,66	142,13
SZC180-2000	4,57	17,91	7,75	50,80	500	270,36	216,28
SZC187-1377	4,75	18,08	7,92	34,98	500	204,35	163,48
SZC187-1747	4,75	18,08	7,92	44,37	500	246,51	197,21
SZC197-1180	5,00	15,80	9,40	37,00	250	84,57	67,66
SZC234-2000	5,94	19,28	9,12	50,80	250	153,37	122,70
SZC236-1180	5,99	19,33	9,17	29,97	250	101,90	81,52
SZC255-910	6,48	19,81	9,65	23,11	250	88,32	70,66

FORME E DIMENSIONI PERSONALIZZATE REALIZZABILI SU RICHIESTA

CODICE CODE	A	B	C	LUNGH. LENGTH	PZ CONF. PCS. BOX	€/CONF. €/BOX	€ 5 CONF (CAD.) € 5 BOX (EACH)
SZC255-1180	6,48	19,81	9,65	29,97	250	106,24	84,99
SZC270-1200	6,86	20,19	10,03	30,48	250	111,10	88,88
SZC275-1180	6,99	20,32	10,16	29,97	250	110,85	88,68
SZC294-1330	7,47	20,80	10,64	33,78	250	125,90	100,72
SZC315-974	8,00	21,34	11,18	24,74	250	104,75	83,80
SZC315-1180	8,00	21,34	11,18	29,97	250	120,08	96,06
SZC315-1425	8,00	21,34	11,18	36,20	250	138,32	110,65
SZC320-670	8,13	21,46	11,30	17,02	250	82,82	66,26
SZC330-1500	8,38	21,72	11,56	38,10	250	147,93	118,35
SZC355-1500	9,02	22,35	12,19	38,10	250	155,07	124,05
SZC360-1000	9,14	22,48	12,32	25,40	250	116,05	92,84
SZC375-1000	9,53	22,86	12,70	25,40	250	119,24	95,40
SZC375-1421	9,53	22,86	12,70	36,09	250	154,01	123,20
SZC394-1180	10,01	23,34	13,18	29,97	250	138,63	110,91
SZC433-1180	11,00	24,33	14,17	29,97	250	147,93	118,34
SZC438-950	11,13	24,46	14,30	24,13	250	128,21	102,57
SZC451-1215	11,46	24,79	14,63	30,86	250	155,68	124,54
SZC485-750	12,32	25,65	15,49	19,05	250	118,64	94,91
SZC485-1013	12,32	25,65	15,49	25,73	250	144,38	115,51
SZC485-1600	12,32	26,29	16,12	40,64	250	175,36	140,29
SZC492-1180	12,50	25,83	15,67	29,97	250	162,38	129,90
SZC531-1180	13,49	26,82	16,66	29,97	100	68,86	55,09
SZC586-512	14,88	28,22	18,06	13,00	100	44,55	35,64
SZC587-374	14,91	28,24	18,08	9,50	100	38,42	30,74
SZC608-493	15,44	28,78	18,62	12,52	100	45,05	36,04
SZC608-1180	15,44	28,78	18,62	29,97	100	76,63	61,30
SZC622-1180	15,80	29,13	18,97	29,97	100	78,04	62,43
SZC622-1575	15,80	29,13	18,97	40,01	100	96,54	77,23
SZC687-1180	17,45	30,78	20,62	29,97	100	84,85	67,88
SZC689-3579	17,50	30,84	20,68	90,91	100	205,93	164,74
SZC725-3120	18,40	28,56	18,40	85,10	100	246,07	196,86
SZC850-410	21,59	34,93	24,77	10,41	100	56,75	45,40
SZC906-3500	23,01	36,35	26,19	88,90	100	253,36	202,68
SZC963-3000	24,46	37,80	27,64	76,20	100	234,30	187,44
SZC980-1500	24,89	38,23	28,07	38,10	100	138,33	110,66
SZC980-1654	24,90	38,00	26,90	42,00	100	106,05	84,84
SZC1118-540	28,40	41,73	31,57	13,72	100	85,87	68,70
SZC1125-5000	28,58	41,91	31,75	127,00	50	209,21	167,36
SZC1230-5000	31,24	44,58	34,42	127,00	50	226,63	181,30
SZC1240-1760	31,50	44,83	34,67	44,70	50	97,46	77,96
SZC1288-4128	32,72	46,05	35,89	104,85	50	199,96	159,97
SZC1567-1517	39,80	53,14	42,98	38,53	50	97,70	78,16
SZC1850-1850	46,99	60,33	50,17	46,99	50	148,92	119,14
SZC1921-1575	48,79	62,13	51,97	40,01	50	143,28	114,63
SZC2244-1811	57,00	70,33	60,17	46,00	25	93,64	74,91
SZC2250-1920	57,15	70,49	60,33	48,77	25	100,27	80,21
SZC2500-2420	63,50	76,84	66,68	61,47	25	131,80	105,44
SZC2660-726	67,56	80,90	70,74	18,44	25	73,30	58,64
SZC2750-2670	69,90	84,40	74,30	69,60	25	155,38	124,31
SZC3000-2920	76,20	89,00	79,38	74,17	25	181,68	145,35
SZC3154-730	80,11	92,68	83,29	18,54	25	93,05	74,44
SZC3425-705	87,00	100,33	90,17	17,91	25	100,29	80,23
SZC3465-819	88,01	101,35	91,19	20,80	25	107,79	86,23
SZC3500-3420	88,90	102,24	92,08	86,87	25	246,85	197,48

Caps



Cappucci conici a rondella 315 °C.

Indicati per rivestimenti in polvere, elettrostatici per immersione liquida e platinatura.



Silicone Conecaps 315 °C.

Recommended for powder coating, E-coating and plating.

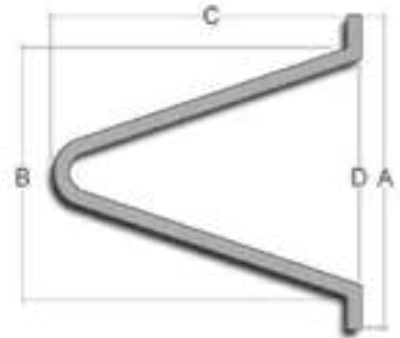

CODICE CODE	DIM. A SIZE A	DIM. B SIZE B	DIM. C SIZE C	DIM. D SIZE D	PZ CONF. PCS. BOX	€/CONF. €/BOX
CCC1	12,70	6,35	23,01	3,30	200	18,36
CCC2	12,70	8,03	25,40	5,49	200	36,72
CCC3	15,88	8,51	25,40	4,50	200	42,84
CCC4	16,51	10,01	27,99	5,00	200	44,98
CCC5	16,13	10,16	27,94	5,84	200	61,24
CCC6	19,05	14,00	35,99	8,00	200	67,36
CCC7	24,89	17,50	38,10	11,51	200	110,2
CCC8	27,94	19,48	51,03	13,51	100	73,48
CCC9	25,40	20,80	49,00	14,81	100	85,72
CCC10	30,99	22,00	53,01	16,00	100	97,96

FORME E DIMENSIONI PERSONALIZZATE REALIZZABILI SU RICHIESTA

**Cappucci con anelli interni 315 °C.**

Gli anelli interni facilitano l'inserimento e l'estrazione su perni/fletti lunghi e di grandi dimensioni ed aumentano la tenuta del cappuccio.

**Caps with rings 315 °C.**

Internal rings allow an easy handling on long pivots/threads with big diameters and increase cap tightness.



CBI
CBI



Caps

CODICE CODE	d (mm)	D (mm)	LUNGH. LENGTH	PZ CONF. PCS. BOX	€/CONF. €/BOX	€ 5 CONF (CAD.) € 5 BOX (EACH)
CBI3-6	3,00	6,00	39,00	100	52,63	42,10
CBI6-9	6,00	9,00	39,00	100	74,18	59,34
CBI9-12	9,00	12,00	39,00	100	95,73	76,58
CBI12-15	12,00	15,00	39,00	100	119,67	95,74
CBI15-18	15,00	18,00	39,00	50	71,81	57,44
CBI18-21	18,00	21,00	39,00	50	84,98	67,98
CBI21-24	21,00	24,00	39,00	50	98,14	78,52
CBI24-27	24,00	27,00	39,00	50	112,51	90,01
CBI27-30	27,00	30,00	52,00	25	79,00	63,20
CBI30-33	30,00	33,00	52,00	25	87,98	70,38
CBI33-36	33,00	36,00	52,00	25	97,56	78,05
CBI36-39	36,00	39,00	52,00	25	107,14	85,71
CBI39-42	39,00	42,00	52,00	25	117,31	93,85
CBI42-45	42,00	45,00	52,00	10	50,99	40,80
CBI45-48	45,00	48,00	52,00	10	55,30	44,24
CBI48-51	48,00	51,00	52,00	10	59,61	47,69
CBI51-54	51,00	54,00	52,00	10	64,16	51,33

FORME E DIMENSIONI PERSONALIZZATE REALIZZABILI SU RICHIESTA

Cappucci



Cappucci a rondella 315 °C.

Cappuccio a doppia funzione. Ideale per mascherare attorno a un foro per la messa a terra.



Washer Caps 315 °C.

Dual purpose plug. Ideal for masking around hole for earthing purpose.

CF

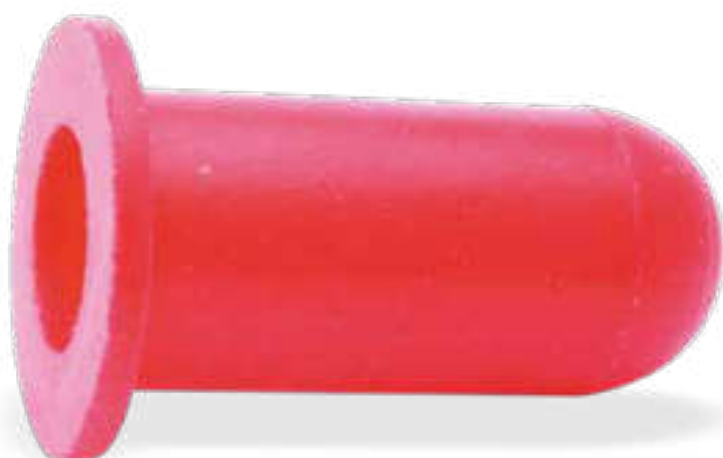
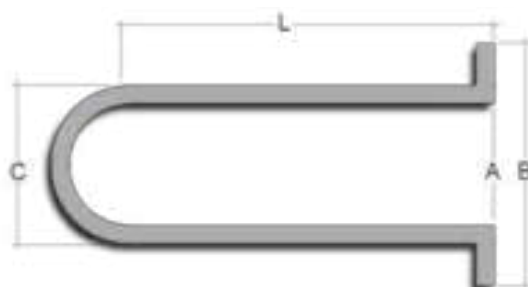

CODICE CODE	A	B	C	LUNGH. LENGTH	PZ. CONF. PCS. BOX	€/CONF. €/BOX
CF100-500	2,54	12,70	5,72	25,40	500	55,11
CF125-500	3,18	12,70	6,40	25,40	500	71,64
CF140-500	3,56	12,70	8,20	25,40	500	95,97
CF156-500	3,96	12,70	8,00	25,40	500	101,00
CF172-500	4,37	12,70	9,70	25,40	500	110,19
CF180-600	4,57	15,24	8,00	25,40	250	45,93
CF220-500	5,59	14,99	9,09	25,40	250	50,52
CF220-787	5,59	19,99	8,71	25,40	250	87,24
CF295-500	7,49	12,70	10,49	25,40	250	74,98
CF295-700	7,49	17,78	10,49	25,40	250	84,44
CF295-1000	7,49	25,40	10,49	25,40	250	99,89
CF300-675	7,62	17,15	10,59	25,40	250	92,51
CF376-825	9,53	20,96	13,00	38,10	250	110,19
CF460-700	11,68	17,78	14,50	25,40	100	72,32
CF500-1000	12,70	25,40	15,39	25,40	100	77,14
CF616-1180	15,62	29,97	20,70	38,10	100	96,42
CF780-1475	19,81	37,47	24,69	25,40	100	114,78

FORME E DIMENSIONI PERSONALIZZATE REALIZZABILI SU RICHIESTA



Cappucci con flangia 315 °C.
Per la protezione di fori filettati e del primo filetto.



Caps with flange 315 °C.
To mask holes and first thread.

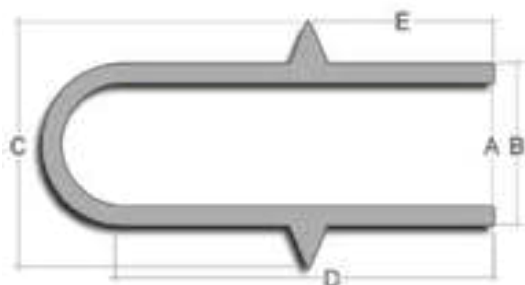

CR^{CR}



Altri materiali
disponibili
Other materials
available

CODICE CODE	COLORE COLOR	A	B	C	D	E	PZ CONF. PCS. BOX	€/CONF. €/BOX
CR8	yellow	4,39	7,39	11,99	30,99	11,99	250	64,92
CR10	pink	5,69	8,71	13,00	32,00	14,71	250	87,53
CR12	clear	7,65	10,69	14,00	33,02	15,80	250	108,19
CR12L	clear	8,00	10,69	14,00	45,66	15,80	250	126,21
CR14	grey	10,69	13,69	15,01	34,04	18,01	250	141,94
CR14L	clear	9,55	12,70	17,02	57,15	17,53	250	205,52

FORME E DIMENSIONI PERSONALIZZATE REALIZZABILI SU RICHIESTA

Codice Code	Descrizione Description	Pag. Page
Nastri - Tapes - Rubans - Klebeband - Cintas - Fitas		
RPT	Nastro verde 204 °C SILICONE FREE - Green Tape 204 °C SILICONE FREE	13
EPTL	Nastro verde 204 °C lungh.250m - Green tape 204 °C 250m length	14
HPT	Nastro verde 204 °C - Green tape 204 °C	14
EPR	Nastro rosso 220 °C - Red tape 220 °C	15
EPB	Nastro blu 204 °C - Blue tape 204 °C	15
STC	Nastro trasparente 204 °C (0,065 mm)- Clear tape 204 °C (0,065 mm)	16
CLT	Nastro trasparente 204 °C (0,09 mm)- Clear tape 204 °C (0,09 mm)	16
11900PET	Nastro biadesivo siliconico	17
PC	Nastro polimide 260 °C - Polyimide tape 260 °C	17
SPG	Nastro in carta ad alta temperatura 190 °C - High temperature masking tape 190 °C	18
EPG	Nastro per mascherature 140 °C - Masking tape 140 °C	18
EGC	Nastro in tessuto di fibra di vetro 260 °C - Glass Cloth tape 260 °C	19
LPG	Nastro in carta per mascheratura 80°C - Semi creped paper masking tape 80°C	19
LALL65	Nastro in alluminio con liner - Aluminium tape with liner	20
LALL70	Nastro in alluminio laminato PET - Aluminium laminated tape	20
FLT	Fine line tape - Fine line tape	21
SRT	Nastro in silicone - Silicone rubber tape	21
Fustellati adesivi - Engineered tape adhesive - Découpes de rubans adhésifs - Technisches für Stanzteile - Troqueles en cinta adhesiva - Corte em fita adhesiva		
EPCL	Dischi adesivi con linguetta 204 °C - Adhesive discs with tab 204 °C	24
QPL	Quadrati in nastro verde 204 °C - Square green tape 204 °C	25
RPL	Rettangoli in nastro verde 204 °C - Rectangles green tape 204 °C	25
EPC	Dischi adesivi in nastro verde 204 °C - Green adhesive discs 204 °C	26
CLD	Bollini adesivi trasparenti 204 °C - Clear adhesive discs 204 °C	26
BPC	Dischi adesivi polimide 260 °C - Polyimide adhesive discs 260 °C	27
EBC	Bollini adesivi blu 204 °C - Blue adhesive discs 204 °C	27
EBV	Bollini adesivi in vinile - White vinyl adhesive discs	28
ALUD	Dischi adesivi in alluminio - Aluminium adhesive discs	28
ELT	Bollini adesivi in carta per mascheratura 80°C - Semi creped paper masking discs 80°C	29
EHT	Bollini adesivi per mascheratura 140°C - Masking adhesive discs 140°C	29
---	Fustellature di precisione in nastro 204 °C - Engineered precision tape die-cut 204 °C	34
Tappi - Plugs - Bouchon - Stopfen - Tapones - Tampas		
TMF	Tappo multi flangia - Multi flange plug	42
AFR	Anelli, frammenti e rondelle - Rings, tube fragments and washers	43
DFPP	Tappi speciali per protezione dadi - Nut protection special plug	44
CSINK	Tappi speciali con flangia 315 °C - Countersink Plugs 135 °C	45
CPP	Tappi con maniglia di estrazione 315 °C - Pull Plugs 135 °C	46
EPP	Tappi EPDM con maniglia di estrazione 177 °C - EPDM Pull Plugs 177 °C	48
EP	Tappi conici 315 °C - Conical Plugs 315 °C	50

Codice Code	Descrizione Description	Pag. Page
BP	Tappi conici EPDM 177 °C - EPDM Conical Plugs 177°C	52
CPHS	Tappi conici con maniglia 315 °C - Conical Plugs with handle 315 °C	54
ETM	Tappi copri-filetto 315°C - Thread mask 315°C	55
MHEP	Tappo conico cavo con maniglia - Hollow conical plug with handle	56
WFP	Tappi con rondella 315°C - Silicone Flange Plugs 315°C	57
HEP	Tappi conici in silicone concavi 315°C - Hollow silicone plugs 315°C	58
FP	Tappi senza flange 315 °C - Flangeless Plugs 315 °C	60
SP	Tappi a gradino 315°C - Step Plugs 315°C	62

Tubi, corde - Tubing, cord - Tubes, cordes - Schläuche, Rundschnur - Tubos, cordones - Tubos, fios

EST	Tubo cavo per rivestimenti in polvere 315 °C - Tubing for Powder Coating 315 °C	36
ETO	Cordoncino pieno per rivestimenti in polvere 315 °C - Cord for Powder Coating 315 °C	37
EZT	Tubo a stella in silicone 315 °C - Silicone star tube 315 °C	38
ASC-QSC	Corda in schiuma di silicone - Silicone foam cord	39

Cappucci - Caps - Capuchons - Kappen - Capuchones - Protetores

EC	Rivestimenti in polvere Cappucci 315 °C - Powder Coating Caps 315 °C	63
EE	Cappucci in E.P.D.M. 177 °C - E.P.D.M. Caps 177 °C	66
EQ	Cappucci copri-faston 315 °C - Square silicone caps 315 °C	69
FC	Cappucci a testa piatta 315 °C - Flat caps 315 °C	70
SZC	Cappucci ad uso facilitato 315 °C - Easy use caps 315 °C	72
CCC	Cappucci conici a rondella 315 °C - Silicone Conecaps 315 °C	74
CBI	Cappucci con anelli interni 315 °C - Caps with rings 315 °C	75
CF	Cappucci a rondella 315 °C - Washer Caps 315 °C	76
CR	Cappucci con flangia 315 °C - Caps with flange 315 °C	77

Altri prodotti - Other items - Autres produits - Sonstige Produkte - Otros productos - Outros produtos

CUT	Distributore automatico taglianastro - Automatic tape-cut dispenser	9
TAI	Termometri adesivi monouso - Single-use adhesive thermometers	9
STICKRP01	Stick per ritocco verniciatura a polvere - Custom made touch-up pencils for powder coating	10
PRO	Vernice spray - Spray paint	11
AAP	Pellicola autoadesiva trasparente - Clear adhesive film	10
SKIT	Starter kit - Starter kit	59

Ganci - Hooks - Crochets - Stahl - Ganchos - Ganchos

HC-HV-T5-T6	Ganci per verniciatura in acciaio - Steel hooks for painting	6
GANCI VERT	Ganci per verniciatura di profili in Al verticali - Hooks for vertical Al profiles painting	7
SW	Ganci girevoli - Swivel hooks	8
---	Ganci speciali - special Hooks	8

EUROMASK®

IN ITALIA

AGENTI
&
DISTRIBUTORI



FINISHING GROUP s.r.l.

Via A. de Gasperi, 31 - 20020 Lainate (MI) - Italia

e-mail: info@euromask-shop.com

www.euromask-shop.com

Tel. +39 02 96780055 - 9691001 - n° verde 800.029.466

Fax +39 02 96782993

**per maggiori informazioni sui nostri prodotti
puoi contattare il nostro distributore di zona**

